



eskate®

**OUR RAW MATERIALS:
STEEL AND LOTS
OF PASSION**

Flanges - Clamping Rings - Bending Solutions



eskate

ESKATE® - YOUR SUPPLIER OF FLANGES, CLAMPING RINGS AND BENDING SOLUTIONS

Our product range encompasses cold formed flanges, rings, hoops and collars made of steel, stainless steel, aluminium and other metals. Additionally we provide clamping ring solutions, cold forming of steel and stainless steel sections or profiles as well as welded assemblies used in machinery and equipment engineering.

Quality, speed and cost-effectiveness are the driving forces behind our daily activities. We are certified under DIN EN ISO 9001:2015 and DIN EN ISO 14001:2015. We manufacture for you at locations in Germany, Poland and the United Arab Emirates (UAE) utilizing the professionalism of our global supply chain for your benefit.

You, as our customer, are the focus of our attention. More than 1500 enterprises already count on us and many of these business relationships have grown over a number of years. We look forward to earning your trust and facilitating your success in the future.

For more than thirty years we have provided fast, uncomplicated service and we are always personally available to you. Call, or mail your request.

We welcome your challenge.

Please feel free to contact us at

Fon +49 5734 6666-6

Fax +49 5734 6666-00

eMail info@eskate.de

We're happy about
our new award:



CONTENTS

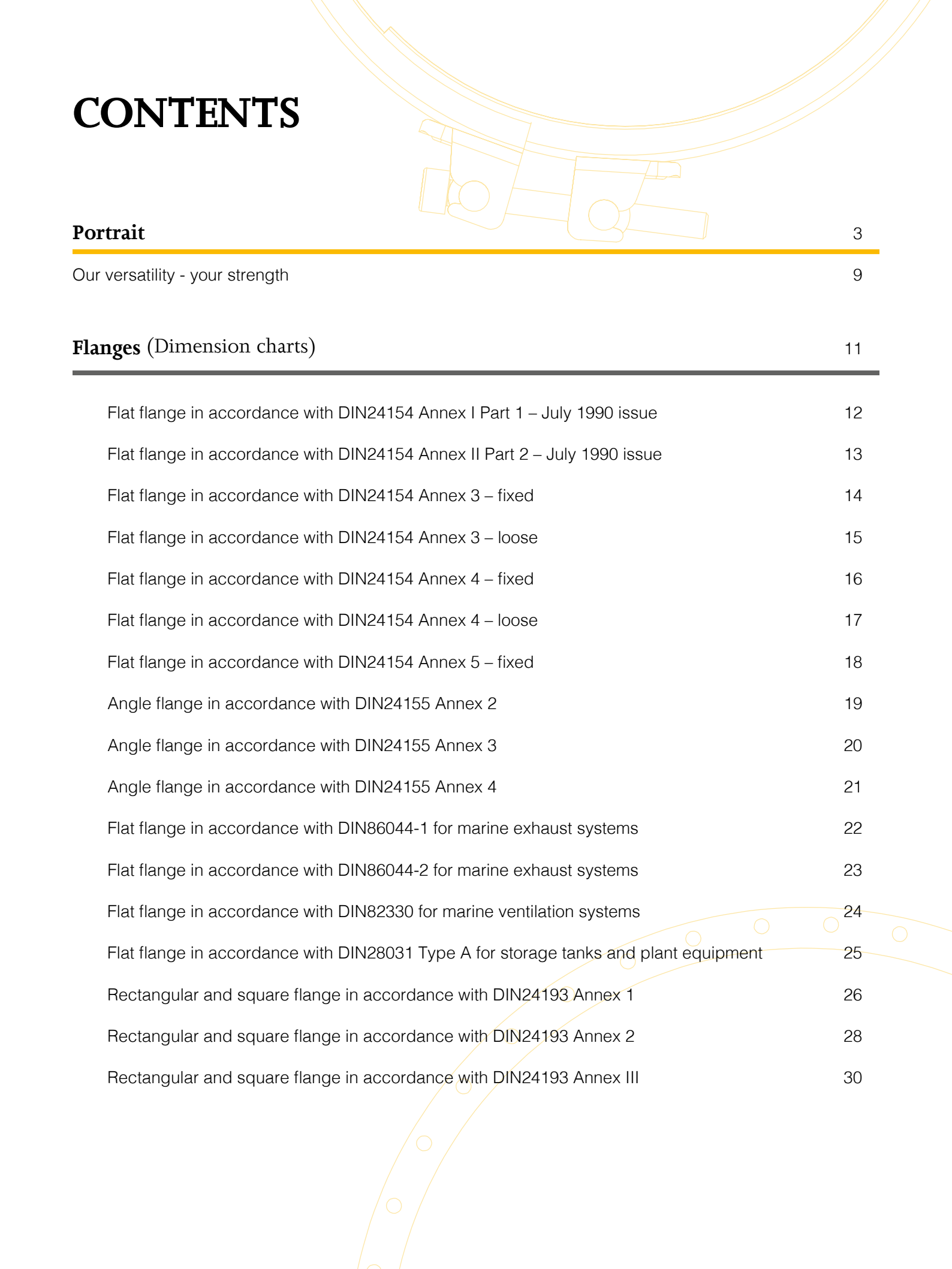

Portrait	3
Our versatility - your strength	9
Flanges (Dimension charts)	11
Flat flange in accordance with DIN24154 Annex I Part 1 – July 1990 issue	12
Flat flange in accordance with DIN24154 Annex II Part 2 – July 1990 issue	13
Flat flange in accordance with DIN24154 Annex 3 – fixed	14
Flat flange in accordance with DIN24154 Annex 3 – loose	15
Flat flange in accordance with DIN24154 Annex 4 – fixed	16
Flat flange in accordance with DIN24154 Annex 4 – loose	17
Flat flange in accordance with DIN24154 Annex 5 – fixed	18
Angle flange in accordance with DIN24155 Annex 2	19
Angle flange in accordance with DIN24155 Annex 3	20
Angle flange in accordance with DIN24155 Annex 4	21
Flat flange in accordance with DIN86044-1 for marine exhaust systems	22
Flat flange in accordance with DIN86044-2 for marine exhaust systems	23
Flat flange in accordance with DIN82330 for marine ventilation systems	24
Flat flange in accordance with DIN28031 Type A for storage tanks and plant equipment	25
Rectangular and square flange in accordance with DIN24193 Annex 1	26
Rectangular and square flange in accordance with DIN24193 Annex 2	28
Rectangular and square flange in accordance with DIN24193 Annex III	30

Clamping Rings & Rim Seals (Dimension charts) 32

Our clamping rings – an overview	34
Safe & Solid clamping ring with quick-close and safety clasp for use with a rim seal	36
Safe & Solid clamping ring with quick-close, without safety clasp for use with rim seal	37
Quick-Close clamping ring for use with rim seal	38
Two-part clamping ring for use with rim seal	39
Rim seal made of NBR/Perbunan, conductive	40
Rim seal made of silicone, conforms to FDA standards	41
Rim seal made of Keltan/APTK/EPDM, conductive and conform to FDA standards	42
Two-part clamping ring for wall thicknesses of 1mm, includes butyl rubber seal	43
Two-part clamping ring for wall thicknesses of 2mm, includes butyl rubber seal	44
Two-part clamping ring for wall thicknesses of 3mm, includes butyl rubber seal	45
One-part clamping ring for wall thicknesses of 1mm, includes butyl rubber seal	46
Wide-strap clamping ring for ducts with longitudinal or spiral seams and crimped rim	47

Bending Technology 51

Bending selections	52
--------------------	----

Service

Design & Development	57
Further manufacturing processes	59
Our speed – Your trump card	61

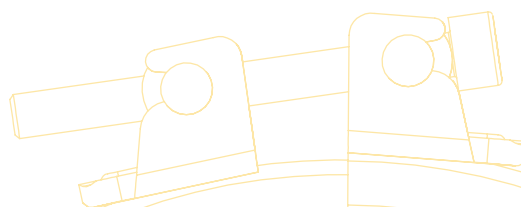

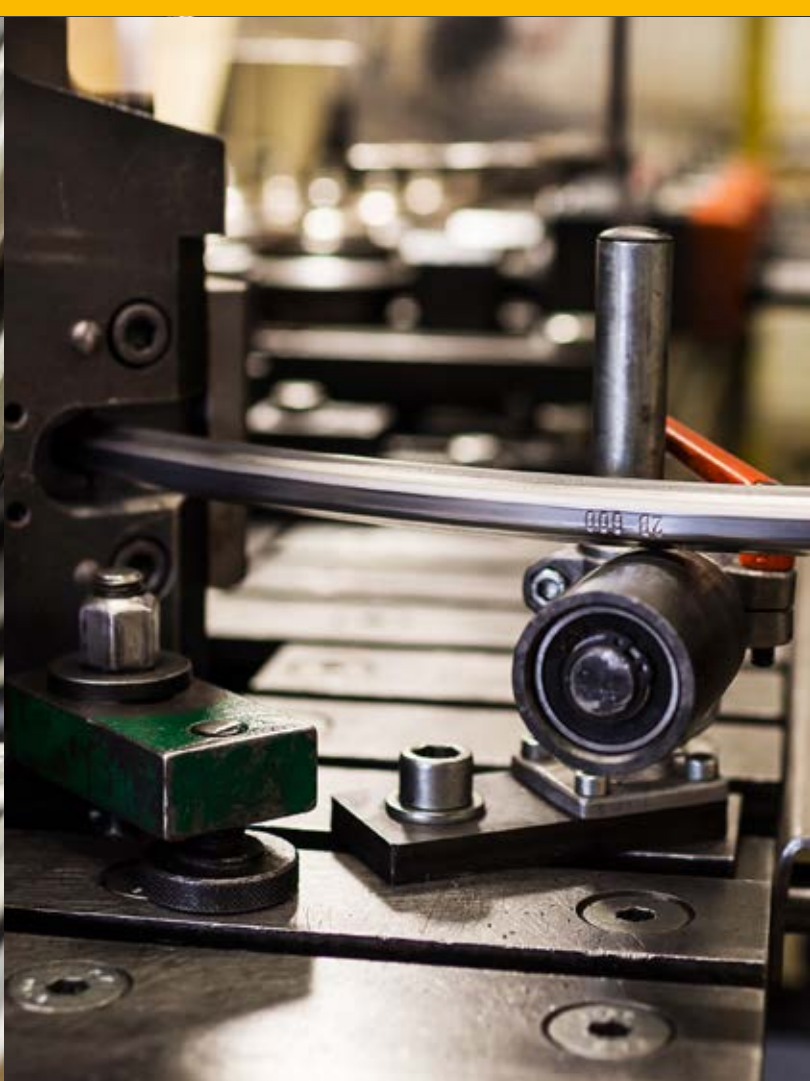





Plant
Equipment



Agriculture



Chemical



Recycling



Pharmaceutical



Automotive



Metalworking



Bespoke Solutions



Construction
Materials



Foodstuffs

OUR VERSATILITY – YOUR STRENGTH

Our pipe connections and formed parts can be found in the most diverse and versatile of applications in a wide array of business sectors and industries. The continuous improvement of manufacturing processes paired with modern production technologies and bending equipment of proprietary design enable us to manufacture high volumes in consistently high quality.

Leading system suppliers employ our products, worldwide, due to their quality and ease of assembly. Our products are, as such, an integral factor in cost effective project execution and avoidance of unpleasant surprises in assembly or operation. We are skilled pragmatists with more than 30 years' experience in the design and manufacture of pipe and duct connections as well as forming parts made of steel, stainless steel and aluminium. Take advantage of our versatility and benefit from our experience.

Pipe and ducting connection solutions for:

- Dust extraction systems
- Ventilation systems
- Conveyor systems for a variety of media
- Filtering, mixing, composting and sorting systems
- Air filtration and particle filters
- Powder coating and paint finishing systems
- Drying systems

Individually formed parts for:

- Steel construction
- Mechanical engineering
- Transport systems
- Silo construction
- Plant engineering
- Sewage technology
- Ornamental design
- Civil engineering
- Offshore engineering
- Bespoke designs
- Storage tanks & pressure vessels
- Environmental technology
- Advertising technology
- Illumination

Products

- Flanges and clamping rings for duct systems, tank & container engineering and clamp top lids
- Bending technology for all industrial sectors to specification
- Assemblies and flame-cut parts for mechanical and plant engineering
- Thrust and angle rings, collars and hoops
- Material- and surface treatment
- Bending technology for all types of vessels and tanks to specification

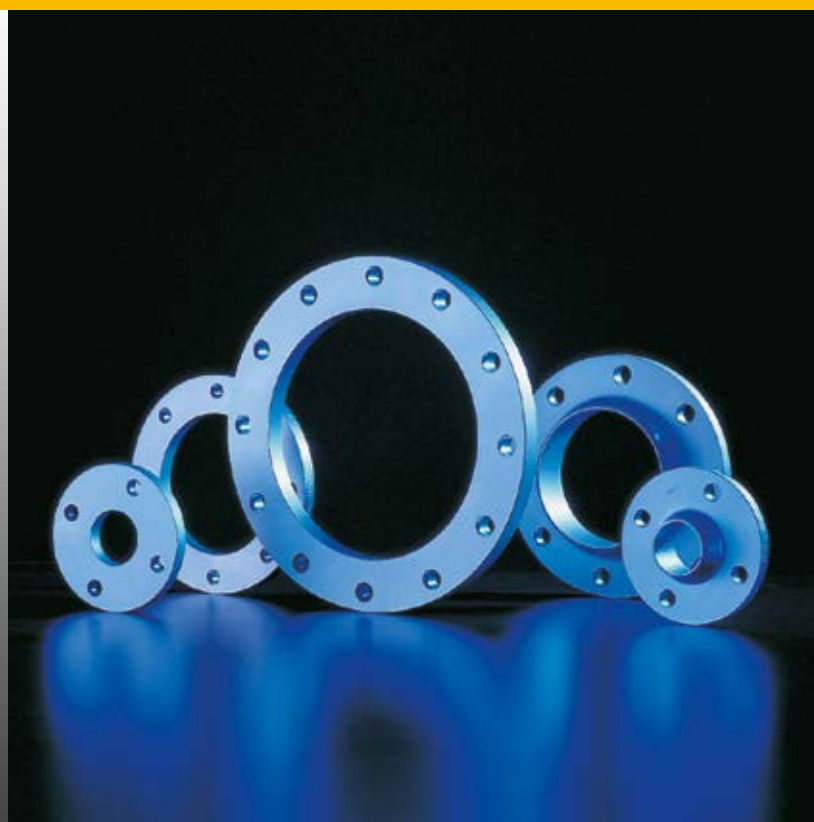

FLANGES

We manufacture and supply flanges of all dimensions and designs for ventilation and exhaust systems, equipment & tank construction for ship-building and many other customer-specific applications. Thanks to the development of proprietary bending machines and the deployment of the latest CNC technologies, we provide our customers with the entire range of flange manufacture.

Bulk, mass and customer-specific batch production is easy, quick and affordable for us to carry out. We permanently stock common DIN and EN flange standards as well as customer-specific factory standards in raw, galvanized and stainless steel versions so they are available to you on call.

- › **Flat flanges** in accordance with DIN24154 (Annex I, II, 3, 4 and 5) for HVAC systems
- › **Flat flanges** in accordance with EN12220 for HVAC systems
- › **Angle flanges** in accordance with DIN24155 (Annex 2, 3 and 4) for HVAC systems
- › **Rectangular and square flanges** in accordance with DIN24193 (Annex 1, 2 and 3)
- › **Flanges for unpressurized vessels and equipment** in accordance with DIN28031
- › **Flanges for marine ventilation systems** in accordance with DIN82330
- › **Flanges for marine exhaust systems** in accordance with DIN86044-1 and DIN86044-2
- › **Bespoke and factory standard flanges**
- › **Segmented flanges** to specification
- › **Expansion flanges**
- › **Tank construction flanges** (also segmented)
- › **Domed flanges**
- › **Support, reinforcement and anchor rings, hoops, collars and tower rings**
- › **Pressure rated flanges** in accordance with DIN2573, DIN2576, DIN2641, DIN2642, DIN2632, DIN2633 (PN 6 – PN 40)
- › **Blind flanges** in accordance with DIN2527 (PN 6 – PN 40)
- › **European flange standards** in accordance with EN1092-1

**WE MANUFACTURE YOUR FLANGES SPECIFICALLY
TO YOUR REQUIREMENTS**

DIN24154 Annex I Part 1

July 1990 Issue

Flat flanges for HVAC Systems

In part identical with EN 12220

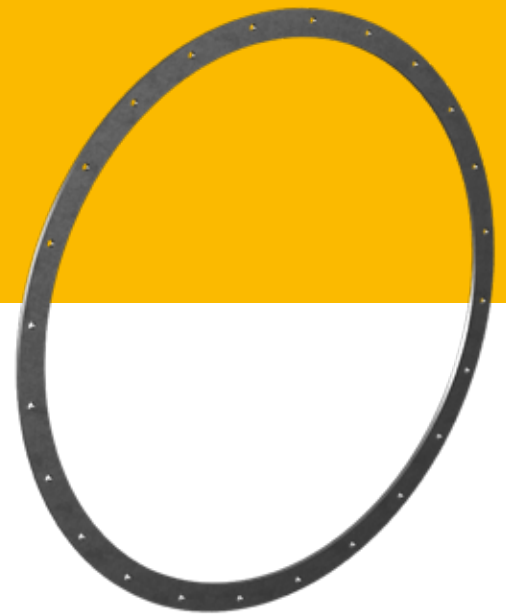

Material

1.0038 mild & galvanized steel

1.4301, 1.4571

further materials on request

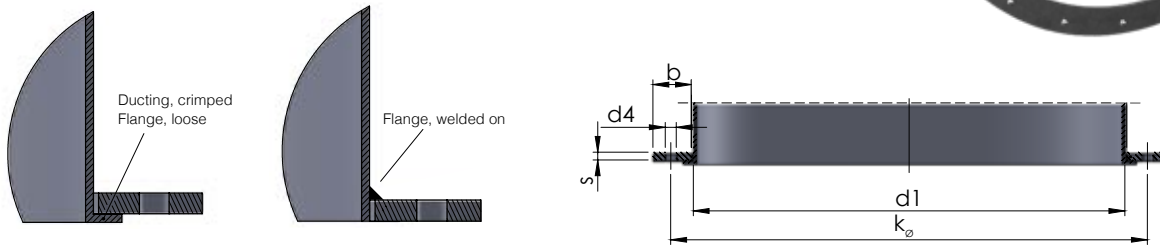

DN Nominal Diameter	Inside- ϕ d1	Material Dimensions (b x s)	Pitch Circle Diameter k_{ϕ}	N $^{\circ}$ of Bolt Holes	Bolt- Hole- ϕ d4	Weight	Part N $^{\circ}$ 1.0038 mild	Part N $^{\circ}$ 1.0038 galvanized	Part N $^{\circ}$ 1.4301	Part N $^{\circ}$ 1.4571
71	73	25 x 3	103	4	9,5	0,17	I-73	I-73-V	I-73-01	I-73-71
80	82	25 x 3	112	4	9,5	0,19	I-82	I-82-V	I-82-01	I-82-71
90	92	25 x 3	122	4	9,5	0,21	I-92	I-92-V	I-92-01	I-92-71
100	102	25 x 3	132	4	9,5	0,23	I-102	I-102-V	I-102-01	I-102-71
112	114	25 x 3	144	4	9,5	0,25	I-114	I-114-V	I-114-01	I-114-71
125	127	25 x 3	157	4	9,5	0,27	I-127	I-127-V	I-127-01	I-127-71
140	142	25 x 4	172	6	9,5	0,40	I-142	I-142-V	I-142-01	I-142-71
150*	152	25 x 4	185	6	9,5	0,42	I-152	I-152-V	I-152-01	I-152-71
160	162	25 x 4	192	6	9,5	0,45	I-162	I-162-V	I-162-01	I-162-71
180	182	25 x 4	212	6	9,5	0,50	I-182	I-182-V	I-182-01	I-182-71
200	203	25 x 4	233	6	9,5	0,55	I-203	I-203-V	I-203-01	I-203-71
224	227	25 x 4	257	6	9,5	0,61	I-227	I-227-V	I-227-01	I-227-71
250	253	25 x 4	283	6	9,5	0,67	I-253	I-253-V	I-253-01	I-253-71
280	283	30 x 4	317	8	9,5	0,91	I-283	I-283-V	I-283-01	I-283-71
300**	303	30 x 4	339	8	9,5	0,97	I-303	I-303-V	I-303-01	I-303-71
315	318	30 x 4	352	8	9,5	1,01	I-318	I-318-V	I-318-01	I-318-71
355	358	30 x 4	392	8	9,5	1,13	I-358	I-358-V	I-358-01	I-358-71
400	404	30 x 4	438	8	9,5	1,27	I-404	I-404-V	I-404-01	I-404-71
450	454	30 x 4	488	8	9,5	1,41	I-454	I-454-V	I-454-01	I-454-71
500	504	30 x 4	538	8	9,5	1,56	I-504	I-504-V	I-504-01	I-504-71
560	564	35 x 4	600	12	9,5	2,04	I-564	I-564-V	I-564-01	I-564-71
600	606	35 x 4	641	12	9,5	2,19	I-606	I-606-V	I-606-01	I-606-71
630	634	35 x 4	670	12	9,5	2,28	I-634	I-634-V	I-634-01	I-634-71
710	714	35 x 4	750	12	9,5	2,56	I-714	I-714-V	I-714-01	I-714-71
800	804	35 x 4	840	16	9,5	2,86	I-804	I-804-V	I-804-01	I-804-71
900	904	35 x 4	940	16	9,5	3,21	I-904	I-904-V	I-904-01	I-904-71
1000	1005	35 x 4	1041	16	9,5	3,56	I-1005	I-1005-V	I-1005-01	I-1005-71
1120	1125	40 x 5	1169	24	9,5	5,68	I-1125	I-1125-V	I-1125-01	I-1125-71
1250	1255	40 x 5	1299	24	9,5	6,32	I-1255	I-1255-V	I-1255-01	I-1255-71
1400	1405	40 x 5	1449	24	9,5	7,06	I-1405	I-1405-V	I-1405-01	I-1405-71
1600	1605	40 x 5	1649	24	9,5	8,05	I-1605	I-1605-V	I-1605-01	I-1605-71
1800	1805	40 x 5	1849	24	9,5	9,03	I-1805	I-1805-V	I-1805-01	I-1805-71
2000	2005	40 x 5	2049	24	9,5	10,02	I-2005	I-2005-V	I-2005-01	I-2005-71

All measurements are in millimetres and weights in kg.

In part identical to the European standard EN 12220 (July 1998 Issue)

* EN 12220 (DN150) stipulates a bolt circle $k_{\phi} = 182$ mm **EN 12220 (DN300) stipulates a bolt circle $k_{\phi} = 337$ mm

DIN24154 Annex II Part 2

July 1990 Issue

Flat flanges for HVAC Systems

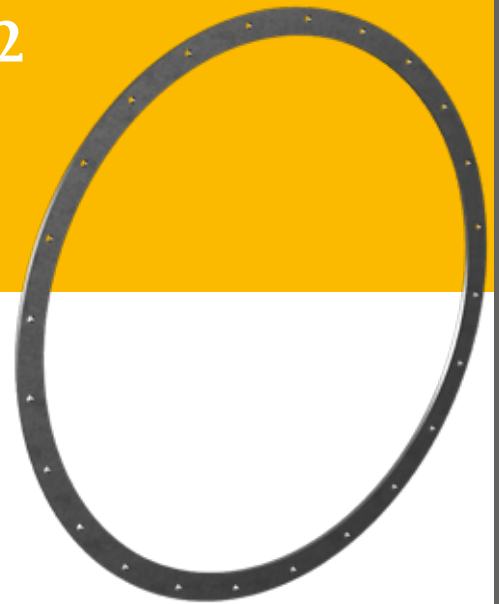

Material

1.0038 mild & galvanized steel

1.4301, 1.4571

further materials on request

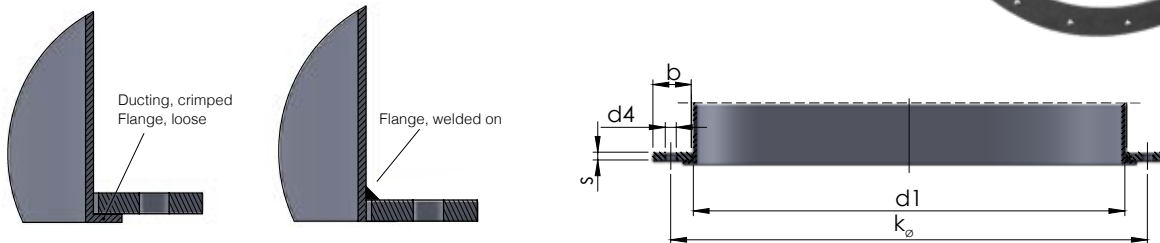

DN Nominal Diameter	Inside- ϕ d1	Material Dimensions (b x s)	Pitch Circle Diameter k_{ϕ}	N $^{\circ}$ of Bolt Holes	Bolt- Hole- ϕ d4	Weight	Part N $^{\circ}$ 1.0038 mild	Part N $^{\circ}$ 1.0038 galvanized	Part N $^{\circ}$ 1.4301	Part N $^{\circ}$ 1.4571
71	73	30 x 6	110	4	9,5	0,44	II-73	II-73-V	II-73-01	II-73-71
80	82	30 x 6	118	4	9,5	0,48	II-82	II-82-V	II-82-01	II-82-71
90	92	30 x 6	128	4	9,5	0,53	II-92	II-92-V	II-92-01	II-92-71
100	102	30 x 6	139	4	9,5	0,57	II-102	II-102-V	II-102-01	II-102-71
112	114	30 x 6	151	4	9,5	0,63	II-114	II-114-V	II-114-01	II-114-71
125	127	30 x 6	165	4	9,5	0,68	II-127	II-127-V	II-127-01	II-127-71
140	142	35 x 6	182	8	11,5	0,88	II-142	II-142-V	II-142-01	II-142-71
150	152	35 x 6	191	8	11,5	0,93	II-152	II-152-V	II-152-01	II-152-71
160	162	35 x 6	200	8	11,5	0,98	II-162	II-162-V	II-162-01	II-162-71
180	182	35 x 6	219	8	11,5	1,08	II-182	II-182-V	II-182-01	II-182-71
200	203	35 x 6	241	8	11,5	1,19	II-203	II-203-V	II-203-01	II-203-71
224	227	35 x 6	265	8	11,5	1,32	II-227	II-227-V	II-227-01	II-227-71
250	253	35 x 6	292	8	11,5	1,45	II-253	II-253-V	II-253-01	II-253-71
280	283	40 x 8	332	8	11,5	2,50	II-283	II-283-V	II-283-01	II-283-71
300	303	40 x 8	349	8	11,5	2,65	II-303	II-303-V	II-303-01	II-303-71
315	318	40 x 8	366	8	11,5	2,77	II-318	II-318-V	II-318-01	II-318-71
355	358	40 x 8	405	8	11,5	3,09	II-358	II-358-V	II-358-01	II-358-71
400	404	40 x 8	448	12	11,5	3,43	II-404	II-404-V	II-404-01	II-404-71
450	454	40 x 8	497	12	11,5	3,82	II-454	II-454-V	II-454-01	II-454-71
500	504	40 x 8	551	12	11,5	4,21	II-504	II-504-V	II-504-01	II-504-71
560	564	50 x 8	629	16	14	5,90	II-564	II-564-V	II-564-01	II-564-71
600	605	50 x 8	665	16	14	6,31	II-605	II-605-V	II-605-01	II-605-71
630	634	50 x 8	698	16	14	6,59	II-634	II-634-V	II-634-01	II-634-71
710	714	50 x 8	775	16	14	7,38	II-714	II-714-V	II-714-01	II-714-71
800	804	50 x 8	861	24	14	8,19	II-804	II-804-V	II-804-01	II-804-71
900	904	50 x 8	958	24	14	9,18	II-904	II-904-V	II-904-01	II-904-71
1000	1005	50 x 8	1067	24	14	10,18	II-1005	II-1005-V	II-1005-01	II-1005-71
1120	1125	60 x 10	1200	32	18	16,90	II-1125	II-1125-V	II-1125-01	II-1125-71
1250	1255	60 x 10	1337	32	18	18,82	II-1255	II-1255-V	II-1255-01	II-1255-71
1400	1405	60 x 10	1475	32	18	21,04	II-1405	II-1405-V	II-1405-01	II-1405-71
1600	1605	60 x 10	1675	40	18	23,84	II-1605	II-1605-V	II-1605-01	II-1605-71
1800	1805	60 x 10	1875	40	18	26,80	II-1805	II-1805-V	II-1805-01	II-1805-71
2000	2005	60 x 10	2073	40	18	29,76	II-2005	II-2005-V	II-2005-01	II-2005-71

All measurements are in millimetres and weights in kg.

Flanges

DIN24154 Annex 3 fixed

July 1966 Issue

Flat flanges for HVAC Systems

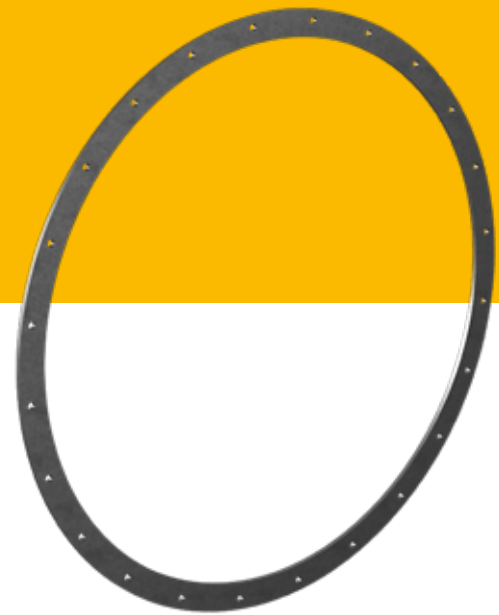

Material

1.0038 mild & galvanized steel

1.4301, 1.4571

further materials on request

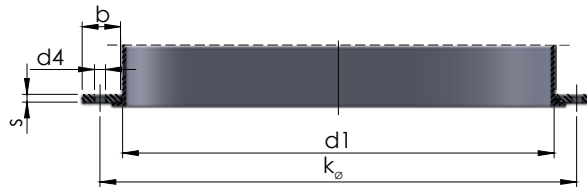
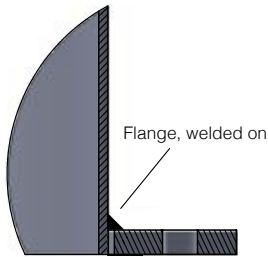

DN Nominal Diameter	Inside-ø d1	Material Dimensions (b x s)	Pitch Circle Diameter k_{\varnothing}	N° of Bolt Holes	Bolt-Hole-ø d4	Weight	Part N° 1.0038 mild	Part N° 1.0038 galvanized	Part N° 1.4301	Part N° 1.4571
63	68	20 x 4	92	4	7	0,17	3-68	3-68-V	3-68-01	3-68-71
71	76	20 x 4	100	4	7	0,18	3-76	3-76-V	3-76-01	3-76-71
80	84	20 x 4	108	4	7	0,20	3-84	3-84-V	3-84-01	3-84-71
90	94	20 x 4	118	4	7	0,22	3-94	3-94-V	3-94-01	3-94-71
100	105	20 x 4	129	4	7	0,24	3-105	3-105-V	3-105-01	3-105-71
112	117	20 x 4	141	4	7	0,27	3-117	3-117-V	3-117-01	3-117-71
125	131	20 x 4	155	4	7	0,29	3-131	3-131-V	3-131-01	3-131-71
140	146	25 x 5	176	6	7	0,52	3-146	3-146-V	3-146-01	3-146-71
150	155	25 x 5	185	6	7	0,55	3-155	3-155-V	3-155-01	3-155-71
160	164	25 x 5	194	6	7	0,57	3-164	3-164-V	3-164-01	3-164-71
180	183	25 x 5	213	6	7	0,63	3-183	3-183-V	3-183-01	3-183-71
200	205	25 x 5	235	6	7	0,70	3-205	3-205-V	3-205-01	3-205-71
224	229	25 x 5	259	6	7	0,77	3-229	3-229-V	3-229-01	3-229-71
250	256	25 x 5	286	6	7	0,86	3-256	3-256-V	3-256-01	3-256-71
280	288	30 x 6	322	8	9,5	1,38	3-288	3-288-V	3-288-01	3-288-71
300	305	30 x 6	339	8	9,5	1,46	3-305	3-305-V	3-305-01	3-305-71
315	322	30 x 6	356	8	9,5	1,54	3-322	3-322-V	3-322-01	3-322-71
350	355	30 x 6	389	8	9,5	1,68	3-355	3-355-V	3-355-01	3-355-71
355	361	30 x 6	395	8	9,5	1,71	3-361	3-361-V	3-361-01	3-361-71
400	404	30 x 6	438	12	9,5	1,89	3-404	3-404-V	3-404-01	3-404-71
450	453	30 x 6	487	12	9,5	2,10	3-453	3-453-V	3-453-01	3-453-71
500	507	30 x 6	541	12	9,5	2,34	3-507	3-507-V	3-507-01	3-507-71
560	569	35 x 6	605	16	11,5	3,05	3-569	3-569-V	3-569-01	3-569-71
600	605	35 x 6	641	16	11,5	3,24	3-605	3-605-V	3-605-01	3-605-71
630	638	35 x 6	674	16	11,5	3,41	3-638	3-638-V	3-638-01	3-638-71
710	715	35 x 6	751	16	11,5	3,81	3-715	3-715-V	3-715-01	3-715-71
800	801	35 x 6	837	24	11,5	4,21	3-801	3-801-V	3-801-01	3-801-71
900	898	35 x 6	934	24	11,5	4,71	3-898	3-898-V	3-898-01	3-898-71
1000	1007	35 x 6	1043	24	11,5	5,28	3-1007	3-1007-V	3-1007-01	3-1007-71
1120	1130	40 x 8	1174	24	11,5	9,08	3-1130	3-1130-V	3-1130-01	3-1130-71
1250	1267	40 x 8	1311	24	11,5	10,16	3-1267	3-1267-V	3-1267-01	3-1267-71
1400	1421	40 x 8	1465	24	11,5	11,37	3-1421	3-1421-V	3-1421-01	3-1421-71
1600	1593	40 x 8	1637	32	11,5	12,68	3-1593	3-1593-V	3-1593-01	3-1593-71
1800	1786	40 x 8	1830	32	11,5	14,20	3-1786	3-1786-V	3-1786-01	3-1786-71
2000	2003	40 x 8	2047	32	11,5	15,91	3-2003	3-2003-V	3-2003-01	3-2003-71

All measurements are in millimetres and weights in kg.

DIN24154 Annex 3 loose

July 1966 Issue

Flat flanges for HVAC Systems

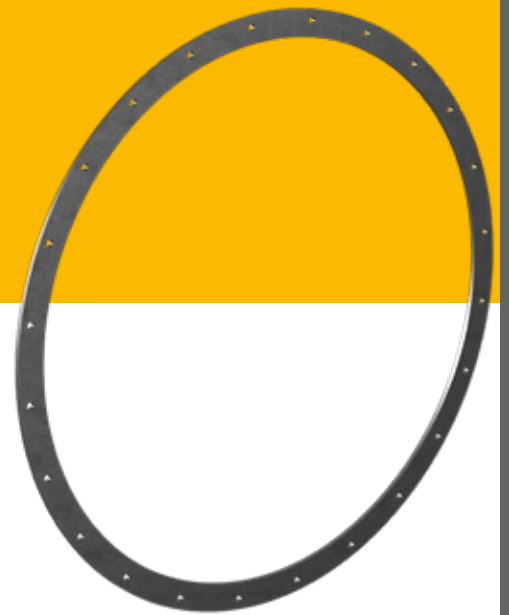

Material

1.0038 mild & galvanized steel

1.4301, 1.4571

further materials on request

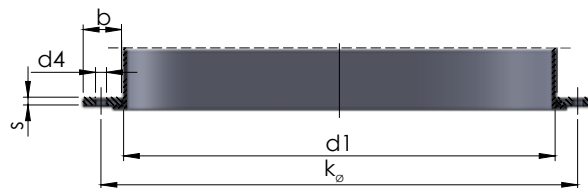
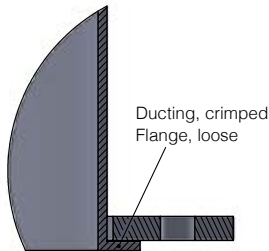

DN Nominal Diameter	Inside-ø d1	Material Dimensions (b x s)	Pitch Circle Diameter k_{ϕ}	N° of Bolt Holes	Bolt-Hole-ø d4	Weight	Part N° 1.0038 mild	Part N° 1.0038 galvanized	Part N° 1.4301	Part N° 1.4571
63	72	20 x 4	92	4	7	0,18	3-72	3-72-V	3-72-01	3-72-71
71	80	20 x 4	100	4	7	0,19	3-80	3-80-V	3-80-01	3-80-71
80	88	20 x 4	108	4	7	0,21	3-88	3-88-V	3-88-01	3-88-71
90	98	20 x 4	118	4	7	0,23	3-98	3-98-V	3-98-01	3-98-71
100	109	20 x 4	129	4	7	0,25	3-109	3-109-V	3-109-01	3-109-71
112	121	20 x 4	141	4	7	0,27	3-121	3-121-V	3-121-01	3-121-71
125	135	20 x 4	155	4	7	0,30	3-135	3-135-V	3-135-01	3-135-71
140	150	25 x 5	176	6	7	0,53	3-150	3-150-V	3-150-01	3-150-71
150	159	25 x 5	185	6	7	0,56	3-159	3-159-V	3-159-01	3-159-71
160	168	25 x 5	194	6	7	0,59	3-168	3-168-V	3-168-01	3-168-71
180	187	25 x 5	213	6	7	0,64	3-187	3-187-V	3-187-01	3-187-71
200	209	25 x 5	235	6	7	0,71	3-209	3-209-V	3-209-01	3-209-71
224	233	25 x 5	259	6	7	0,79	3-233	3-233-V	3-233-01	3-233-71
250	260	25 x 5	286	6	7	0,87	3-260	3-260-V	3-260-01	3-260-71
280	292	30 x 6	322	8	9,5	1,40	3-292	3-292-V	3-292-01	3-292-71
300	309	30 x 6	339	8	9,5	1,48	3-309	3-309-V	3-309-01	3-309-71
315	326	30 x 6	356	8	9,5	1,55	3-326	3-326-V	3-326-01	3-326-71
350	359	30 x 6	389	8	9,5	1,70	3-359	3-359-V	3-359-01	3-359-71
355	365	30 x 6	395	8	9,5	1,73	3-365	3-365-V	3-365-01	3-365-71
400	408	30 x 6	438	12	9,5	1,90	3-408	3-408-V	3-408-01	3-408-71
450	457	30 x 6	487	12	9,5	2,12	3-457	3-457-V	3-457-01	3-457-71
500	511	30 x 6	541	12	9,5	2,36	3-511	3-511-V	3-511-01	3-511-71
560	573	35 x 6	605	16	11,5	3,07	3-573	3-573-V	3-573-01	3-573-71
600	609	35 x 6	641	16	11,5	3,26	3-609	3-609-V	3-609-01	3-609-71
630	642	35 x 6	674	16	11,5	3,43	3-642	3-642-V	3-642-01	3-642-71
710	719	35 x 6	751	16	11,5	3,83	3-719	3-719-V	3-719-01	3-719-71
800	805	35 x 6	837	24	11,5	4,23	3-805	3-805-V	3-805-01	3-805-71
900	902	35 x 6	934	24	11,5	4,74	3-902	3-902-V	3-902-01	3-902-71
1000	1011	35 x 6	1043	24	11,5	5,30	3-1011	3-1011-V	3-1011-01	3-1011-71
1120	1134	40 x 8	1174	24	11,5	9,11	3-1134	3-1134-V	3-1134-01	3-1134-71
1250	1271	40 x 8	1311	24	11,5	10,19	3-1271	3-1271-V	3-1271-01	3-1271-71
1400	1425	40 x 8	1465	24	11,5	11,40	3-1425	3-1425-V	3-1425-01	3-1425-71
1600	1597	40 x 8	1637	32	11,5	12,71	3-1597	3-1597-V	3-1597-01	3-1597-71
1800	1790	40 x 8	1830	32	11,5	14,23	3-1790	3-1790-V	3-1790-01	3-1790-71
2000	2007	40 x 8	2047	32	11,5	15,95	3-2007	3-2007-V	3-2007-01	3-2007-71

All measurements are in millimetres and weights in kg.

DIN24154 Annex 4 fixed

July 1966 Issue

Flat flanges for HVAC Systems

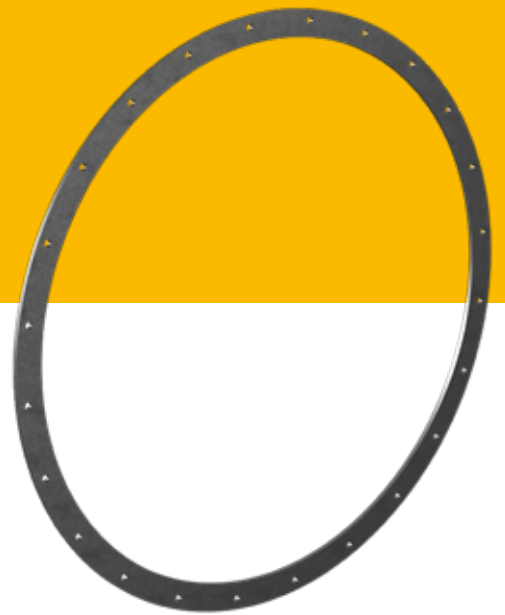

Material

1.0038 mild & galvanized steel

1.4301, 1.4571

further materials on request

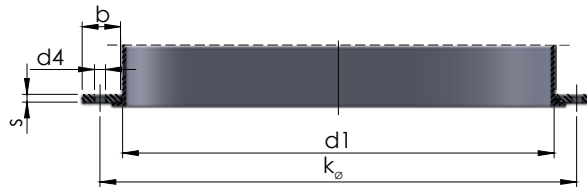
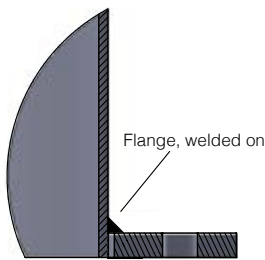

DN Nominal Diameter	Inside-ø d1	Material Dimensions (b x s)	Pitch Circle Diameter k _ø	N° of Bolt Holes	Bolt- Hole-ø d4	Weight	Part N° 1.0038 mild	Part N° 1.0038 galvanized	Part N° 1.4301	Part N° 1.4571
63	68	30 x 6	102	4	9,5	0,42	4-68	4-68-V	4-68-01	4-68-71
71	76	30 x 6	110	4	9,5	0,46	4-76	4-76-V	4-76-01	4-76-71
80	84	30 x 6	118	4	9,5	0,49	4-84	4-84-V	4-84-01	4-84-71
90	94	30 x 6	128	4	9,5	0,54	4-94	4-94-V	4-94-01	4-94-71
100	105	30 x 6	139	4	9,5	0,59	4-105	4-105-V	4-105-01	4-105-71
112	117	30 x 6	151	4	9,5	0,64	4-117	4-117-V	4-117-01	4-117-71
125	131	30 x 6	165	4	9,5	0,70	4-131	4-131-V	4-131-01	4-131-71
140	146	35 x 6	182	8	11,5	0,90	4-146	4-146-V	4-146-01	4-146-71
150	155	35 x 6	191	8	11,5	0,94	4-155	4-155-V	4-155-01	4-155-71
160	164	35 x 6	200	8	11,5	0,99	4-164	4-164-V	4-164-01	4-164-71
180	183	35 x 6	219	8	11,5	1,09	4-183	4-183-V	4-183-01	4-183-71
200	205	35 x 6	241	8	11,5	1,20	4-205	4-205-V	4-205-01	4-205-71
224	229	35 x 6	265	8	11,5	1,33	4-229	4-229-V	4-229-01	4-229-71
250	256	35 x 6	292	8	11,5	1,47	4-256	4-256-V	4-256-01	4-256-71
280	288	40 x 8	332	8	11,5	2,54	4-288	4-288-V	4-288-01	4-288-71
300	305	40 x 8	349	8	11,5	2,67	4-305	4-305-V	4-305-01	4-305-71
315	322	40 x 8	366	8	11,5	2,80	4-322	4-322-V	4-322-01	4-322-71
350	355	40 x 8	399	8	11,5	3,07	4-355	4-355-V	4-355-01	4-355-71
355	361	40 x 8	405	8	11,5	3,11	4-361	4-361-V	4-361-01	4-361-71
400	404	40 x 8	448	12	11,5	3,43	4-404	4-404-V	4-404-01	4-404-71
450	453	40 x 8	497	12	11,5	3,81	4-453	4-453-V	4-453-01	4-453-71
500	507	40 x 8	551	12	11,5	4,24	4-507	4-507-V	4-507-01	4-507-71
560	569	50 x 8	629	16	14	5,95	4-569	4-569-V	4-569-01	4-569-71
600	605	50 x 8	665	16	14	6,31	4-605	4-605-V	4-605-01	4-605-71
630	638	50 x 8	698	16	14	6,63	4-638	4-638-V	4-638-01	4-638-71
710	715	50 x 8	775	16	14	7,39	4-715	4-715-V	4-715-01	4-715-71
800	801	50 x 8	861	24	14	8,16	4-801	4-801-V	4-801-01	4-801-71
900	898	50 x 8	958	24	14	9,12	4-898	4-898-V	4-898-01	4-898-71
1000	1007	50 x 8	1067	24	14	10,19	4-1007	4-1007-V	4-1007-01	4-1007-71
1120	1130	60 x 10	1200	32	18	16,97	4-1130	4-1130-V	4-1130-01	4-1130-71
1250	1267	60 x 10	1337	32	18	19,00	4-1267	4-1267-V	4-1267-01	4-1267-71
1400	1421	60 x 10	1491	32	18	21,27	4-1421	4-1421-V	4-1421-01	4-1421-71
1600	1593	60 x 10	1663	40	18	23,66	4-1593	4-1593-V	4-1593-01	4-1593-71
1800	1786	60 x 10	1856	40	18	26,52	4-1786	4-1786-V	4-1786-01	4-1786-71
2000	2003	60 x 10	2073	40	18	29,73	4-2003	4-2003-V	4-2003-01	4-2003-71

All measurements are in millimetres and weights in kg.

DIN24154 Annex 4 loose

July 1966 Issue

Flat flanges for HVAC Systems

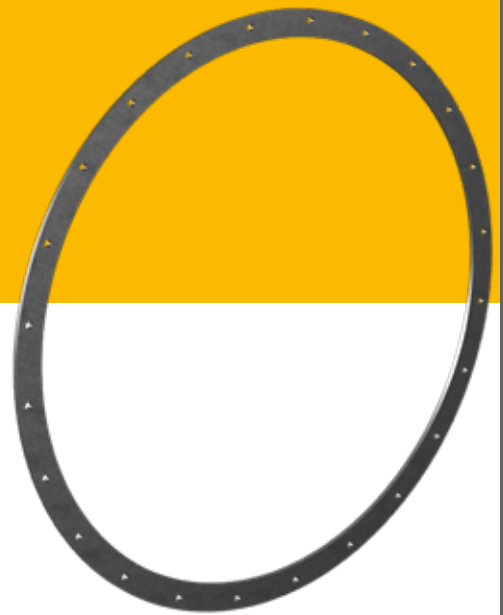

Material

1.0038 mild & galvanized steel

1.4301, 1.4571

further materials on request

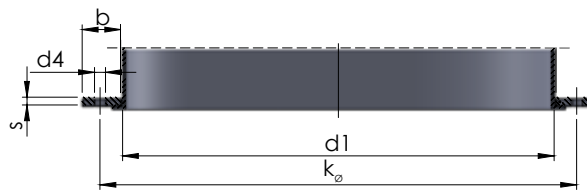
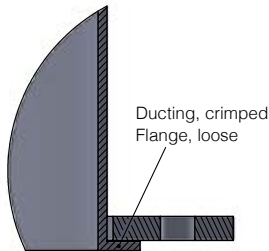

DN Nominal Diameter	Inside-ø d1	Material Dimensions (b x s)	Pitch Circle Diameter $k_ø$	N° of Bolt Holes	Bolt-Hole-ø d4	Weight	Part N° 1.0038 mild	Part N° 1.0038 galvanized	Part N° 1.4301	Part N° 1.4571
63	72	30 x 6	102	4	9,5	0,44	4-72	4-72-V	4-72-01	4-72-71
71	80	30 x 6	110	4	9,5	0,47	4-80	4-80-V	4-80-01	4-80-71
80	88	30 x 6	118	4	9,5	0,51	4-88	4-88-V	4-88-01	4-88-71
90	98	30 x 6	128	4	9,5	0,55	4-98	4-98-V	4-98-01	4-98-71
100	109	30 x 6	139	4	9,5	0,60	4-109	4-109-V	4-109-01	4-109-71
112	121	30 x 6	151	4	9,5	0,66	4-121	4-121-V	4-121-01	4-121-71
125	135	30 x 6	165	4	9,5	0,72	4-135	4-135-V	4-135-01	4-135-71
140	150	35 x 6	182	8	11,5	0,92	4-150	4-150-V	4-150-01	4-150-71
150	159	35 x 6	191	8	11,5	0,97	4-159	4-159-V	4-159-01	4-159-71
160	168	35 x 6	200	8	11,5	1,01	4-168	4-168-V	4-168-01	4-168-71
180	187	35 x 6	219	8	11,5	1,11	4-187	4-187-V	4-187-01	4-187-71
200	209	35 x 6	241	8	11,5	1,22	4-209	4-209-V	4-209-01	4-209-71
224	233	35 x 6	265	8	11,5	1,35	4-233	4-233-V	4-233-01	4-233-71
250	260	35 x 6	292	8	11,5	1,49	4-260	4-260-V	4-260-01	4-260-71
280	292	40 x 8	332	8	11,5	2,57	4-292	4-292-V	4-292-01	4-292-71
300	309	40 x 8	349	8	11,5	2,70	4-309	4-309-V	4-309-01	4-309-71
315	326	40 x 8	366	8	11,5	2,84	4-326	4-326-V	4-326-01	4-326-71
350	359	40 x 8	399	8	11,5	3,10	4-359	4-359-V	4-359-01	4-359-71
355	365	40 x 8	405	8	11,5	3,14	4-365	4-365-V	4-365-01	4-365-71
400	408	40 x 8	448	12	11,5	3,46	4-408	4-408-V	4-408-01	4-408-71
450	457	40 x 8	497	12	11,5	3,84	4-457	4-457-V	4-457-01	4-457-71
500	511	40 x 8	551	12	11,5	4,27	4-511	4-511-V	4-511-01	4-511-71
560	573	50 x 8	629	16	14	5,99	4-573	4-573-V	4-573-01	4-573-71
600	609	50 x 8	665	16	14	6,35	4-609	4-609-V	4-609-01	4-609-71
630	642	50 x 8	698	16	14	6,67	4-642	4-642-V	4-642-01	4-642-71
710	719	50 x 8	775	16	14	7,43	4-719	4-719-V	4-719-01	4-719-71
800	805	50 x 8	861	24	14	8,20	4-805	4-805-V	4-805-01	4-805-71
900	902	50 x 8	958	24	14	9,16	4-902	4-902-V	4-902-01	4-902-71
1000	1011	50 x 8	1067	24	14	10,23	4-1011	4-1011-V	4-1011-01	4-1011-71
1120	1134	60 x 10	1200	32	18	17,03	4-1134	4-1134-V	4-1134-01	4-1134-71
1250	1271	60 x 10	1337	32	18	19,06	4-1271	4-1271-V	4-1271-01	4-1271-71
1400	1425	60 x 10	1491	32	18	21,33	4-1425	4-1425-V	4-1425-01	4-1425-71
1600	1597	60 x 10	1663	40	18	23,72	4-1597	4-1597-V	4-1597-01	4-1597-71
1800	1790	60 x 10	1856	40	18	26,58	4-1790	4-1790-V	4-1790-01	4-1790-71
2000	2007	60 x 10	2073	40	18	29,79	4-2007	4-2007-V	4-2007-01	4-2007-71

All measurements are in millimetres and weights in kg.

DIN24154 Annex 5

October 1975 Issue

Flat flanges for HVAC Systems

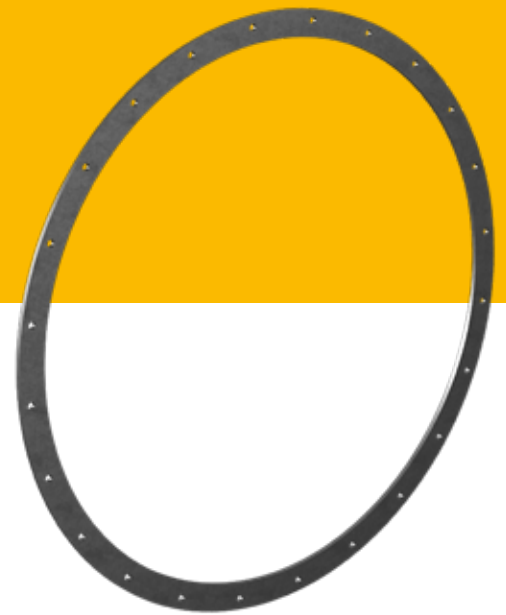

Material

1.0038 mild & galvanized steel

1.4301, 1.4571

further materials on request

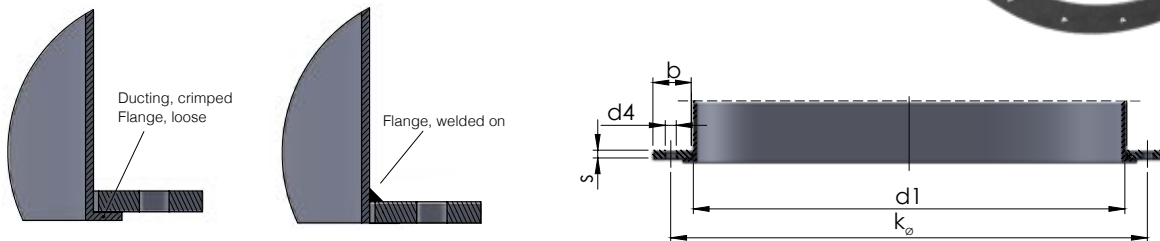

DN Nominal Diameter	Inside-ø d1	Material Dimensions (b x s)	Pitch Circle Diameter k_{ϕ}	N° of Bolt Holes	Bolt- Hole-ø d4	Weight	Part N° 1.0038 mild	Part N° 1.0038 galvanized	Part N° 1.4301	Part N° 1.4571
71	73	25 x 4	100	4	7	0,24	5-73	5-73-V	5-73-01	5-73-71
80	82	25 x 4	108	4	7	0,26	5-82	5-82-V	5-82-01	5-82-71
90	92	25 x 4	118	4	7	0,28	5-92	5-92-V	5-92-01	5-92-71
100	102	25 x 4	129	4	7	0,31	5-102	5-102-V	5-102-01	5-102-71
112	114	25 x 4	141	4	7	0,34	5-114	5-114-V	5-114-01	5-114-71
125	127	25 x 4	155	4	7	0,37	5-127	5-127-V	5-127-01	5-127-71
140	142	30 x 4	176	6	7	0,50	5-142	5-142-V	5-142-01	5-142-71
150	152	30 x 4	185	6	7	0,53	5-152	5-152-V	5-152-01	5-152-71
160	162	30 x 4	194	6	7	0,56	5-162	5-162-V	5-162-01	5-162-71
180	182	30 x 4	213	6	7	0,62	5-182	5-182-V	5-182-01	5-182-71
200	203	30 x 4	235	6	7	0,68	5-203	5-203-V	5-203-01	5-203-71
224	227	30 x 4	259	6	7	0,75	5-227	5-227-V	5-227-01	5-227-71
250	253	30 x 4	286	6	7	0,83	5-253	5-253-V	5-253-01	5-253-71
280	283	35 x 5	322	8	9,5	0,91	5-283	5-283-V	5-283-01	5-283-71
300	303	35 x 5	342	8	9,5	1,44	5-303	5-303-V	5-303-01	5-303-71
315	318	35 x 5	356	8	9,5	1,50	5-318	5-318-V	5-318-01	5-318-71
355	358	35 x 5	395	8	9,5	1,67	5-358	5-358-V	5-358-01	5-358-71
400	404	35 x 5	438	12	9,5	1,86	5-404	5-404-V	5-404-01	5-404-71
450	454	35 x 5	487	12	9,5	2,08	5-454	5-454-V	5-454-01	5-454-71
500	504	35 x 5	541	12	9,5	2,29	5-504	5-504-V	5-504-01	5-504-71
560	564	45 x 6	629	16	11,5	3,98	5-564	5-564-V	5-564-01	5-564-71
600	606	45 x 6	666	16	11,5	4,26	5-606	5-606-V	5-606-01	5-606-71
630	636	45 x 6	698	16	11,5	4,44	5-636	5-636-V	5-636-01	5-636-71
710	714	45 x 6	775	16	11,5	4,98	5-714	5-714-V	5-714-01	5-714-71
800	804	45 x 6	861	24	11,5	5,54	5-804	5-804-V	5-804-01	5-804-71
900	904	45 x 6	958	24	11,5	6,20	5-904	5-904-V	5-904-01	5-904-71
1000	1005	45 x 6	1067	24	11,5	6,87	5-1005	5-1005-V	5-1005-01	5-1005-71
1120	1125	55 x 8	1200	32	11,5	13,82	5-1125	5-1125-V	5-1125-01	5-1125-71
1250	1255	55 x 8	1337	32	11,5	15,36	5-1255	5-1255-V	5-1255-01	5-1255-71
1400	1405	55 x 8	1491	32	11,5	17,13	5-1405	5-1405-V	5-1405-01	5-1405-71
1600	1605	55 x 8	1663	40	11,5	19,45	5-1605	5-1605-V	5-1605-01	5-1605-71
1800	1805	55 x 8	1856	40	11,5	21,82	5-1805	5-1805-V	5-1805-01	5-1805-71
2000	2005	55 x 8	2073	40	11,5	24,18	5-2005	5-2005-V	5-2005-01	5-2005-71

All measurements are in millimetres and weights in kg.

DIN24155 Annex 2

July 1966 Issue

Angle flanges for HVAC Systems



Material

1.0038 mild & galvanized steel

1.4301, 1.4571

further materials on request

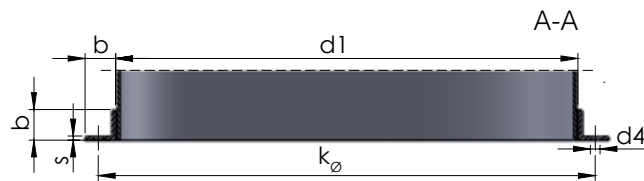
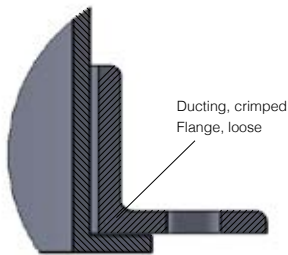

DN Nominal Diameter	Inside- ϕ d1	Material Dimensions (b x b x s)	Pitch Circle Diameter k_{ϕ}	N° of Bolt Holes	Bolt- Hole- ϕ d4	Weight	Part N° 1.0038 mild	Part N° 1.0038 galvanized	Part N° 1.4301	Part N° 1.4571
140	146	25 x 25 x 3	176	6	7	0,66	24155-2-146	24155-2-146-V	24155-2-146-01	24155-2-146-71
150	155	25 x 25 x 3	185	6	7	0,63	24155-2-155	24155-2-155-V	24155-2-155-01	24155-2-155-71
160	164	25 x 25 x 3	194	6	7	0,66	24155-2-164	24155-2-164-V	24155-2-164-01	24155-2-164-71
180	183	25 x 25 x 3	213	6	7	0,72	24155-2-183	24155-2-183-V	24155-2-183-01	24155-2-183-71
200	205	25 x 25 x 3	235	6	7	0,80	24155-2-205	24155-2-205-V	24155-2-205-01	24155-2-205-71
224	229	25 x 25 x 3	259	6	7	0,88	24155-2-229	24155-2-229-V	24155-2-229-01	24155-2-229-71
250	256	25 x 25 x 3	286	6	7	0,98	24155-2-256	24155-2-256-V	24155-2-256-01	24155-2-256-71
280	288	30 x 30 x 4	322	8	9,5	1,76	24155-2-288	24155-2-288-V	24155-2-288-01	24155-2-288-71
300	305	30 x 30 x 4	339	8	9,5	1,85	24155-2-305	24155-2-305-V	24155-2-305-01	24155-2-305-71
315	322	30 x 30 x 4	356	8	9,5	1,94	24155-2-322	24155-2-322-V	24155-2-322-01	24155-2-322-71
350	355	30 x 30 x 4	394	8	9,5	2,13	24155-2-355	24155-2-355-V	24155-2-355-01	24155-2-355-71
355	361	30 x 30 x 4	395	8	9,5	2,16	24155-2-361	24155-2-361-V	24155-2-361-01	24155-2-361-71
400	404	30 x 30 x 4	438	12	9,5	2,40	24155-2-404	24155-2-404-V	24155-2-404-01	24155-2-404-71
450	453	30 x 30 x 4	487	12	9,5	2,67	24155-2-453	24155-2-453-V	24155-2-453-01	24155-2-453-71
500	507	30 x 30 x 4	541	12	9,5	2,97	24155-2-507	24155-2-507-V	24155-2-507-01	24155-2-507-71
560	569	35 x 35 x 4	605	16	11,5	3,93	24155-2-569	24155-2-569-V	24155-2-569-01	24155-2-569-71
600	605	35 x 35 x 4	641	16	11,5	4,15	24155-2-605	24155-2-605-V	24155-2-605-01	24155-2-605-71
630	638	35 x 35 x 4	674	16	11,5	4,38	24155-2-638	24155-2-638-V	24155-2-638-01	24155-2-638-71
710	715	35 x 35 x 4	751	16	11,5	4,88	24155-2-715	24155-2-715-V	24155-2-715-01	24155-2-715-71
800	801	35 x 35 x 4	837	24	11,5	5,44	24155-2-801	24155-2-801-V	24155-2-801-01	24155-2-801-71
900	898	35 x 35 x 4	934	24	11,5	6,07	24155-2-898	24155-2-898-V	24155-2-898-01	24155-2-898-71
1000	1007	35 x 35 x 4	1043	24	11,5	6,78	24155-2-1007	24155-2-1007-V	24155-2-1007-01	24155-2-1007-71
1120	1130	40 x 40 x 4	1174	24	11,5	8,77	24155-2-1130	24155-2-1130-V	24155-2-1130-01	24155-2-1130-71
1250	1267	40 x 40 x 4	1311	24	11,5	9,80	24155-2-1267	24155-2-1267-V	24155-2-1267-01	24155-2-1267-71
1400	1421	40 x 40 x 4	1465	24	11,5	10,95	24155-2-1421	24155-2-1421-V	24155-2-1421-01	24155-2-1421-71
1600	1593	40 x 40 x 4	1637	32	11,5	12,24	24155-2-1593	24155-2-1593-V	24155-2-1593-01	24155-2-1593-71
1800	1786	40 x 40 x 4	1830	32	11,5	13,69	24155-2-1786	24155-2-1786-V	24155-2-1786-01	24155-2-1786-71
2000	2003	40 x 40 x 4	2047	32	11,5	15,32	24155-2-2003	24155-2-2003-V	24155-2-2003-01	24155-2-2003-71

All measurements are in millimetres and weights in kg.

DIN24155 Annex 3

July 1966 Issue

Angle flanges for HVAC Systems



Material

1.0038 mild & galvanized steel

1.4301, 1.4571

further materials on request

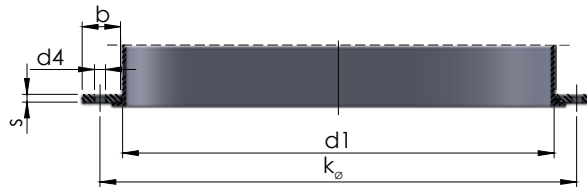
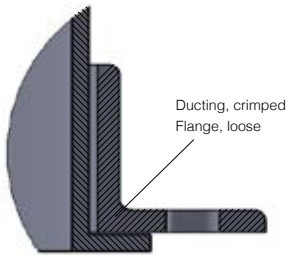

DN Nominal Diameter	Inside- ϕ d1	Material Dimensions (b x b x s)	Pitch Circle Diameter k_{ϕ}	N° of Bolt Holes	Bolt- Hole- ϕ d4	Weight	Part N° 1.0038 mild	Part N° 1.0038 galvanized	Part N° 1.4301	Part N° 1.4571
140	146	25 x 25 x 4	176	6	7	0,78	24155-3-146	24155-3-146-V	24155-3-146-01	24155-3-146-71
150	155	25 x 25 x 4	185	6	7	0,82	24155-3-155	24155-3-155-V	24155-3-155-01	24155-3-155-71
160	164	25 x 25 x 4	194	6	7	0,86	24155-3-164	24155-3-164-V	24155-3-164-01	24155-3-164-71
180	183	25 x 25 x 4	213	6	7	0,94	24155-3-183	24155-3-183-V	24155-3-183-01	24155-3-183-71
200	205	25 x 25 x 4	235	6	7	1,04	24155-3-205	24155-3-205-V	24155-3-205-01	24155-3-205-71
224	229	25 x 25 x 4	259	6	7	1,15	24155-3-229	24155-3-229-V	24155-3-229-01	24155-3-229-71
250	256	25 x 25 x 4	286	6	7	1,28	24155-3-256	24155-3-256-V	24155-3-256-01	24155-3-256-71
280	288	30 x 30 x 5	322	8	9,5	2,16	24155-3-288	24155-3-288-V	24155-3-288-01	24155-3-288-71
300	305	30 x 30 x 5	339	8	9,5	2,27	24155-3-305	24155-3-305-V	24155-3-305-01	24155-3-305-71
315	322	30 x 30 x 5	356	8	9,5	2,39	24155-3-322	24155-3-322-V	24155-3-322-01	24155-3-322-71
350	355	30 x 30 x 5	389	8	9,5	2,61	24155-3-355	24155-3-355-V	24155-3-355-01	24155-3-355-71
355	361	30 x 30 x 5	395	8	9,5	2,65	24155-3-361	24155-3-361-V	24155-3-361-01	24155-3-361-71
400	404	30 x 30 x 5	438	12	9,5	2,94	24155-3-404	24155-3-404-V	24155-3-404-01	24155-3-404-71
450	453	30 x 30 x 5	487	12	9,5	3,28	24155-3-453	24155-3-453-V	24155-3-453-01	24155-3-453-71
500	507	30 x 30 x 5	541	12	9,5	3,64	24155-3-507	24155-3-507-V	24155-3-507-01	24155-3-507-71
560	569	35 x 35 x 5	605	16	11,5	4,84	24155-3-569	24155-3-569-V	24155-3-569-01	24155-3-569-71
600	605	35 x 35 x 5	641	16	11,5	5,13	24155-3-605	24155-3-605-V	24155-3-605-01	24155-3-605-71
630	638	35 x 35 x 5	674	16	11,5	5,39	24155-3-638	24155-3-638-V	24155-3-638-01	24155-3-638-71
710	715	35 x 35 x 5	751	16	11,5	6,01	24155-3-715	24155-3-715-V	24155-3-715-01	24155-3-715-71
800	801	35 x 35 x 5	837	24	11,5	6,70	24155-3-801	24155-3-801-V	24155-3-801-01	24155-3-801-71
900	898	35 x 35 x 5	934	24	11,5	7,48	24155-3-898	24155-3-898-V	24155-3-898-01	24155-3-898-71
1000	1007	35 x 35 x 5	1043	24	11,5	8,35	24155-3-1007	24155-3-1007-V	24155-3-1007-01	24155-3-1007-71
1120	1130	40 x 40 x 6	1174	24	11,5	12,81	24155-3-1130	24155-3-1130-V	24155-3-1130-01	24155-3-1130-71
1250	1267	40 x 40 x 6	1311	24	11,5	14,31	24155-3-1267	24155-3-1267-V	24155-3-1267-01	24155-3-1267-71
1400	1421	40 x 40 x 6	1465	24	11,5	16,00	24155-3-1421	24155-3-1421-V	24155-3-1421-01	24155-3-1421-71
1600	1593	40 x 40 x 6	1637	32	11,5	17,88	24155-3-1593	24155-3-1593-V	24155-3-1593-01	24155-3-1593-71
1800	1786	40 x 40 x 6	1830	32	11,5	19,99	24155-3-1786	24155-3-1786-V	24155-3-1786-01	24155-3-1786-71
2000	2003	40 x 40 x 6	2047	32	11,5	22,37	24155-3-2003	24155-3-2003-V	24155-3-2003-01	24155-3-2003-71

All measurements are in millimetres and weights in kg.

DIN24155 Annex 4

July 1966 Issue

Angle flanges for HVAC Systems



Material

1.0038 mild & galvanized steel

1.4301, 1.4571

further materials on request

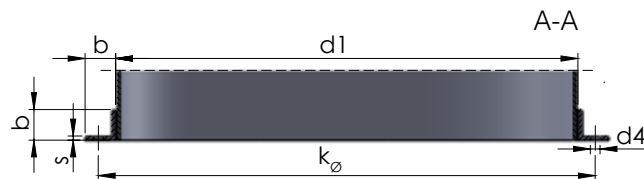
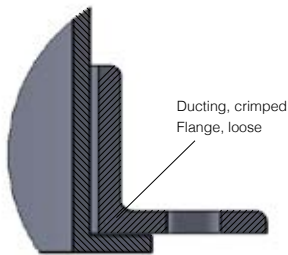

DN Nominal Diameter	Inside-ø d1	Material Dimensions (b x b x s)	Pitch Circle Diameter k_{ϕ}	N° of Bolt Holes	Bolt- Hole-ø d4	Weight	Part N° 1.0038 mild	Part N° 1.0038 galvanized	Part N° 1.4301	Part N° 1.4571
140	146	35 x 35 x 5	182	8	11,5	1,45	24155-4-146	24155-4-146-V	24155-4-146-01	24155-4-146-71
150	155	35 x 35 x 5	191	8	11,5	1,52	24155-4-155	24155-4-155-V	24155-4-155-01	24155-4-155-71
160	164	35 x 35 x 5	200	8	11,5	1,59	24155-4-164	24155-4-164-V	24155-4-164-01	24155-4-164-71
180	183	35 x 35 x 5	219	8	11,5	1,75	24155-4-183	24155-4-183-V	24155-4-183-01	24155-4-183-71
200	205	35 x 35 x 5	241	8	11,5	1,92	24155-4-205	24155-4-205-V	24155-4-205-01	24155-4-205-71
224	229	35 x 35 x 5	265	8	11,5	2,12	24155-4-229	24155-4-229-V	24155-4-229-01	24155-4-229-71
250	256	35 x 35 x 5	292	8	11,5	2,33	24155-4-256	24155-4-256-V	24155-4-256-01	24155-4-256-71
280	288	40 x 40 x 6	332	8	11,5	3,59	24155-4-288	24155-4-288-V	24155-4-288-01	24155-4-288-71
300	305	40 x 40 x 6	349	8	11,5	3,78	24155-4-305	24155-4-305-V	24155-4-305-01	24155-4-305-71
315	322	40 x 40 x 6	366	8	11,5	3,96	24155-4-322	24155-4-322-V	24155-4-322-01	24155-4-322-71
350	355	40 x 40 x 6	399	8	11,5	4,33	24155-4-355	24155-4-355-V	24155-4-355-01	24155-4-355-71
355	361	40 x 40 x 6	405	8	11,5	4,39	24155-4-361	24155-4-361-V	24155-4-361-01	24155-4-361-71
400	404	40 x 40 x 6	448	12	11,5	4,86	24155-4-404	24155-4-404-V	24155-4-404-01	24155-4-404-71
450	453	40 x 40 x 6	497	12	11,5	5,40	24155-4-453	24155-4-453-V	24155-4-453-01	24155-4-453-71
500	507	40 x 40 x 6	551	12	11,5	5,99	24155-4-507	24155-4-507-V	24155-4-507-01	24155-4-507-71
560	569	50 x 50 x 6	629	16	14	8,61	24155-4-569	24155-4-569-V	24155-4-569-01	24155-4-569-71
600	605	50 x 50 x 6	665	16	14	9,11	24155-4-605	24155-4-605-V	24155-4-605-01	24155-4-605-71
630	638	50 x 50 x 6	698	16	14	9,57	24155-4-638	24155-4-638-V	24155-4-638-01	24155-4-638-71
710	715	50 x 50 x 6	775	16	14	10,64	24155-4-715	24155-4-715-V	24155-4-715-01	24155-4-715-71
800	801	50 x 50 x 6	861	24	14	11,84	24155-4-801	24155-4-801-V	24155-4-801-01	24155-4-801-71
900	898	50 x 50 x 6	958	24	14	13,19	24155-4-898	24155-4-898-V	24155-4-898-01	24155-4-898-71
1000	1007	50 x 50 x 6	1067	24	14	14,70	24155-4-1007	24155-4-1007-V	24155-4-1007-01	24155-4-1007-71
1120	1130	60 x 60 x 8	1200	32	18	26,30	24155-4-1130	24155-4-1130-V	24155-4-1130-01	24155-4-1130-71
1250	1267	60 x 60 x 8	1337	32	18	29,32	24155-4-1267	24155-4-1267-V	24155-4-1267-01	24155-4-1267-71
1400	1421	60 x 60 x 8	1491	32	18	32,73	24155-4-1421	24155-4-1421-V	24155-4-1421-01	24155-4-1421-71
1600	1593	60 x 60 x 8	1663	40	18	36,53	24155-4-1593	24155-4-1593-V	24155-4-1593-01	24155-4-1593-71
1800	1786	60 x 60 x 8	1856	40	18	40,79	24155-4-1786	24155-4-1786-V	24155-4-1786-01	24155-4-1786-71
2000	2003	60 x 60 x 8	2073	40	18	45,59	24155-4-2003	24155-4-2003-V	24155-4-2003-01	24155-4-2003-71

All measurements are in millimetres and weights in kg.

For stainless steel materials, the material thickness s deviates from the DIN.

Similar to DIN86044-1

September 1980 Issue

Flat flanges for marine exhaust systems



Material

1.0038 mild steel

further materials on request

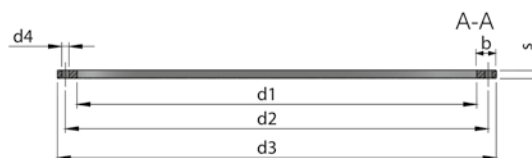

DN Nominal Diameter	Inside-ø d1	Outside-ø d3	Width b	Material Thickness s	Pitch Circle Diameter d2	N ° of Bolt Holes	Bolt-Hole-ø d4	Bolts	Weight	Part N°
32	43	140	-	15	100	4	18	M16	1,75	86044-43
40	48	150	-	15	110	4	18	M16	1,99	86044-48
50	61	165	-	15	125	4	18	M16	2,61	86044-61
65	77	185	-	15	145	4	18	M16	3,14	86044-77
80	90	200	-	15	160	8	18	M16	3,93	86044-90
100	116	220	-	15	180	8	18	M16	4,31	86044-116
125	142	250	-	15	210	8	18	M16	5,76	86044-142
150	171	285	-	15	240	8	22	M20	7,07	86044-171
200	222	320	-	15	280	8	18	M16	5,24	86044-222
250	276	375	-	15	335	12	18	M16	6,36	86044-276
300	327	440	-	15	395	12	22	M20	8,55	86044-327
350	359	490	-	15	445	12	22	M20	10,97	86044-359
400	410	540	-	15	495	16	22	M20	12,18	86044-410
450	461	595	-	15	550	16	22	M20	13,96	86044-461
500	512	645	-	15	600	20	22	M20	15,18	86044-512
550	563	-	70	20	650	20	22	M20	21,86	86044-563
600	614	-	70	20	700	20	22	M20	23,62	86044-614
650	665	-	70	20	750	20	22	M20	25,38	86044-665
700	716	-	70	20	800	24	22	M20	27,14	86044-716
750	767	-	70	20	860	24	22	M20	28,90	86044-767
800	818	-	70	20	900	24	22	M20	30,66	86044-818
850	870	-	70	20	950	28	22	M20	32,45	86044-870
900	920	-	70	20	1010	28	22	M20	34,18	86044-920
950	970	-	70	20	1060	28	22	M20	35,91	86044-970
1000	1022	-	70	20	1110	32	22	M20	37,70	86044-1022
1100	1126	-	70	20	1210	32	22	M20	41,29	86044-1126
1200	1226	-	70	20	1310	36	22	M20	44,75	86044-1226
1300	1326	-	70	20	1410	40	22	M20	48,20	86044-1326
1400	1426	-	70	20	1510	40	22	M20	51,65	86044-1426
1500	1526	-	70	20	1610	44	22	M20	55,10	86044-1526
1600	1626	-	70	20	1710	48	22	M20	58,56	86044-1626
1700	1726	-	70	20	1810	48	22	M20	62,01	86044-1726
1800	1826	-	70	20	1910	52	22	M20	65,46	86044-1826
1900	1926	-	70	20	2010	56	22	M20	68,91	86044-1926
2000	2026	-	70	20	2110	56	22	M20	72,37	86044-2026
2100	2126	-	70	20	2210	60	22	M20	75,82	86044-2126
2200	2226	-	70	20	2310	64	22	M20	79,27	86044-2226
2300	2326	-	70	20	2410	64	22	M20	82,72	86044-2326
2400	2426	-	70	20	2510	68	22	M20	86,18	86044-2426
2500	2526	-	70	20	2610	72	22	M20	89,63	86044-2526
2600	2626	-	70	20	2710	72	22	M20	93,08	86044-2626
2700	2726	-	70	20	2810	76	22	M20	96,53	86044-2726
2800	2826	-	70	20	2910	80	22	M20	99,99	86044-2826
2900	2926	-	70	20	3010	80	22	M20	103,44	86044-2926
3000	3026	-	70	20	3110	84	22	M20	106,89	86044-3026

All measurements are in millimetres and weights in kg.

Similar to DIN86044-2

January 2013 Issue

Flat flanges for marine exhaust systems



Material

1.0038 mild steel
further materials on request

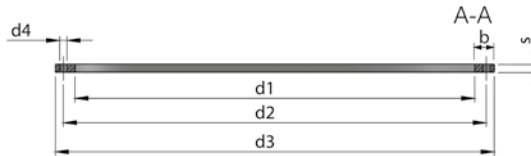

DN Nominal Diameter	Inside-ø d1	Outside-ø d3	Width b	Material Thickness s	Pitch Circle Diameter d2	N ° of Bolt Holes	Bolt-Hole-ø d4	Bolts	Weight	Part N°
32	43	123	-	10	98	8	14	M12	0,72	86044-2-43
40	49	129	-	10	104	8	14	M12	0,78	86044-2-49
50	61	143	-	10	118	8	14	M12	0,93	86044-2-61
65	77	159	-	10	134	8	14	M12	1,09	86044-2-77
80	90	172	-	10	147	12	14	M12	1,17	86044-2-90
100	116	201	-	12	176	12	14	M12	1,81	86044-2-116
125	142	227	-	12	202	12	14	M12	2,13	86044-2-142
150	171	256	-	12	231	16	14	M12	2,44	86044-2-171
200	222	319	-	12	289	12	18	M16	3,75	86044-2-222
250	276	373	-	15	343	16	18	M16	5,31	86044-2-276
300	328	-	50	15	394	20	18	M16	6,04	86044-2-328
350	360	-	50	15	426	20	18	M16	6,60	86044-2-360
400	411	-	50	15	477	20	18	M16	7,50	86044-2-411
450	462	-	50	15	528	24	18	M16	8,28	86044-2-462
500	514	-	50	15	579	28	18	M16	8,97	86044-2-514
600	614	-	50	15	681	32	18	M16	10,90	86044-2-614
700	716	-	50	15	783	36	18	M16	12,60	86044-2-716
800	818	-	50	15	885	44	18	M16	14,10	86044-2-818
900	920	-	50	15	987	48	18	M16	15,80	86044-2-920
1000	1022	-	50	15	1089	52	18	M16	17,50	86044-2-1022
1100	1126	-	50	15	1193	60	18	M16	19,10	86044-2-1126
1200	1226	-	50	15	1293	64	18	M16	20,80	86044-2-1226
1300	1326	-	50	15	1393	68	18	M16	22,50	86044-2-1326
1400	1426	-	50	15	1493	72	18	M16	24,10	86044-2-1426
1500	1526	-	50	15	1593	76	18	M16	25,80	86044-2-1526
1600	1626	-	50	15	1693	80	18	M16	27,50	86044-2-1626
1700	1726	-	50	15	1793	84	18	M16	29,10	86044-2-1726
1800	1826	-	50	15	1893	92	18	M16	30,70	86044-2-1826
1900	1926	-	50	15	1993	96	18	M16	32,20	86044-2-1926
2000	2026	-	50	15	2093	100	18	M16	34,00	86044-2-2026
2100	2126	-	50	15	2193	108	18	M16	35,50	86044-2-2126
2200	2226	-	50	15	2293	112	18	M16	37,20	86044-2-2226
2300	2326	-	50	15	2393	116	18	M16	38,90	86044-2-2326
2400	2426	-	50	15	2493	120	18	M16	40,50	86044-2-2426
2500	2526	-	50	15	2593	128	18	M16	42,10	86044-2-2526
2600	2626	-	50	15	2693	132	18	M16	43,40	86044-2-2626
2700	2726	-	50	15	2793	136	18	M16	45,40	86044-2-2726
2800	2826	-	50	15	2893	140	18	M16	47,10	86044-2-2826
2900	2926	-	50	15	2993	148	18	M16	48,60	86044-2-2926
3000	3026	-	50	15	3093	152	18	M16	50,30	86044-2-3026

All measurements are in millimetres and weights in kg.

DIN82330

December 1998 Issue

Flanges for marine ventilation systems

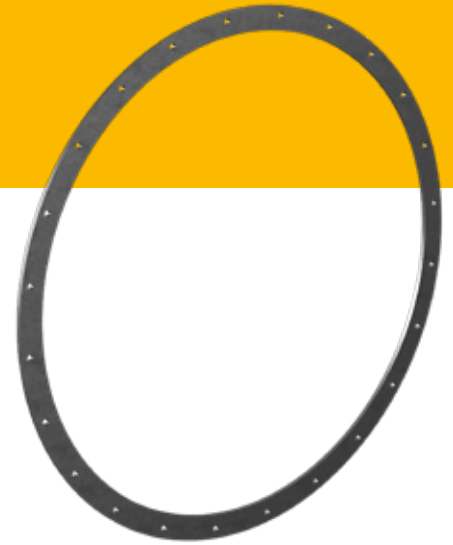

Material

1.0038 mild & galvanized steel

1.4301, 1.4571

further materials on request

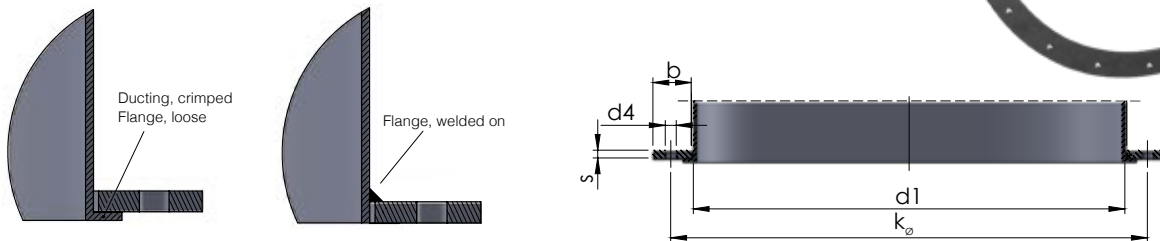

DN Nominal Diameter	Inside- ϕ d1	Material Dimensions (b x s)	Pitch Circle Diameter k_{ϕ}	N° of Bolt Holes	Bolt-Hole- ϕ d4	Weight	Part N° 1.0038 mild
250	275	40 x 8	325	12	14,5	2,36	82330-2-275
280	305	40 x 8	355	12	14,5	2,6	82330-2-305
315	340	40 x 8	390	12	14,5	2,87	82330-2-340
355	381	40 x 8	430	16	14,5	3,16	82330-2-381
400	426	40 x 8	475	16	14,5	3,51	82330-2-426
450	477	40 x 8	525	20	14,5	3,87	82330-2-477
500	527	40 x 8	575	20	14,5	4,27	82330-2-527
560	588	50 x 10	650	20	18,5	5,77	82330-2-588
630	658	50 x 10	720	20	18,5	6,46	82330-2-658
710	739	50 x 10	800	20	18,5	7,26	82330-2-739
800	830	50 x 10	890	24	18,5	8,08	82330-2-830
900	931	50 x 10	990	24	18,5	9,07	82330-2-931
1000	1032	50 x 10	1090	28	18,5	9,98	82330-2-1032
1120	1153	60 x 12	1230	28	24	20,35	82330-2-1153
1250	1284	60 x 12	1360	28	24	22,67	82330-2-1284
1400	1435	60 x 12	1510	32	24	25,18	82330-2-1435
1600	1636	60 x 12	1710	36	24	28,58	82330-2-1636
1800	1837	60 x 12	1910	40	24	31,98	82330-2-1837

All measurements are in millimetres and weights in kg.

Similar to DIN28031 Type A

September 2013 Issue

Flanges for unpressurized vessels, for storage tanks and plant equipment



Material

1.0038 mild & galvanized steel
1.4301, 1.4571
further materials on request

Gasket surface can be machined on request. Material thickness will be reduced by 1.5 – 2.0mm.

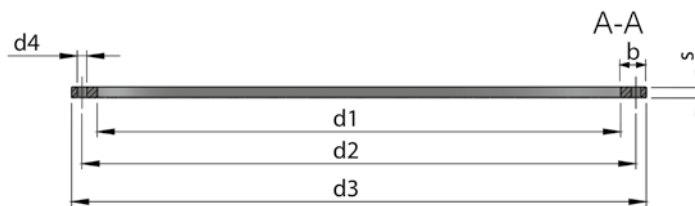

DN Nominal Diameter	Inside- ϕ d1	Material Dimension (b x s) DIN1017	Pitch Circle Diameter d2	N° of Bolt Holes	Bolt-Hole- ϕ d4	Bolts	Tank walls with unalloyed steel	Tank walls with rustproof steel	Weight	Part N° 1.0038 mild
300	326	45 x 20	375	12	18	M 16	5	4	7,76	28031-326
350	357	50 x 20	420	16	18	M 16	5	4	9,40	28031-357
400	408	50 x 20	470	16	18	M 16	5	4	10,66	28031-408
500	510	45 x 20	560	20	18	M 16	5	4	11,52	28031-510
600	602	50 x 20	660	24	18	M 16	5	4	15,12	28031-602
700	702	50 x 20	760	28	18	M 16	5	4	17,43	28031-702
800	802	50 x 20	860	32	18	M 16	5	4	19,73	28031-802
900	902	50 x 20	960	36	18	M 16	5	4	22,04	28031-902
1000	1002	50 x 20	1060	40	18	M 16	5	4	24,35	28031-1002
1100	1102	50 x 20	1160	44	18	M 16	6	5	26,65	28031-1102
1200	1202	60 x 25	1270	48	18	M 16	6	5	44,29	28031-1202
1300	1303	60 x 25	1370	48	18	M 16	6	5	48,02	28031-1303
1400	1403	60 x 25	1470	48	18	M 16	6	5	51,72	28031-1403
1500	1503	60 x 25	1570	52	18	M 16	6	5	55,22	28031-1503
1600	1603	60 x 25	1670	56	18	M 16	6	5	58,72	28031-1603
1700	1703	60 x 25	1770	56	18	M 16	6	5	62,42	28031-1703
1800	1803	60 x 30	1870	56	23	M 20	8	6	77,22	28031-1803
2000	2003	60 x 30	2070	64	23	M 20	8	6	85,32	28031-2003
2200	2203	60 x 30	2270	72	23	M 20	8	6	93,41	28031-2203
2400	2403	60 x 30	2475	72	23	M 20	8	6	102,29	28031-2403
2600	2603	60 x 30	2675	80	23	M 20	8	6	110,38	28031-2603
2800	2803	60 x 30	2875	88	23	M 20	8	6	118,48	28031-2803
3000	3003	60 x 30	3075	96	23	M 20	8	6	126,58	28031-3003
3200	3203	60 x 30	3275	96	23	M 20	8	6	135,45	28031-3203
3400	3403	70 x 40	3490	104	23	M 20	8	6	226,25	28031-3403
3600	3603	70 x 40	3690	112	23	M 20	8	6	239,02	28031-3603
3800	3803	70 x 40	3890	112	23	M 20	8	6	252,83	28031-3803
4000	4003	70 x 40	4090	120	23	M 20	8	6	265,59	28031-4003

All measurements are in millimetres and weights in kg.

DIN24193 - Annex 1

February 1988 Issue

Rectangular and square flanges for HVAC systems

Material

1.0038 mild & galvanized steel

1.4301, 1.4571

further materials on request

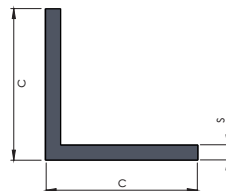

Form L

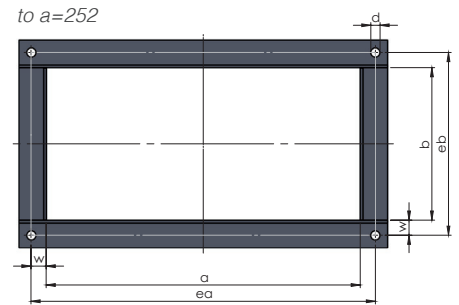

DN Nominal Size	Inside Width / Length a / b	ea / eb	xa / xb	Divisor na / nb	N° of Bolt Holes nea / neb	Mark Out Line w	Angle Steel c x c x s	Bolt Hole Diameter d	Weight kg/m	Bolts
100	102	136	-	-	2	17	30 x 30 x 3	9,5	1,36	M 8
106	108	142	-	-	2	17	30 x 30 x 3	9,5	1,36	M 8
112	114	148	-	-	2	17	30 x 30 x 3	9,5	1,36	M 8
118	120	154	-	-	2	17	30 x 30 x 3	9,5	1,36	M 8
125	127	161	-	-	2	17	30 x 30 x 3	9,5	1,36	M 8
132	134	168	-	-	2	17	30 x 30 x 3	9,5	1,36	M 8
140	142	176	-	-	2	17	30 x 30 x 3	9,5	1,36	M 8
150	152	186	-	-	2	17	30 x 30 x 3	9,5	1,36	M 8
160	162	196	-	-	2	17	30 x 30 x 3	9,5	1,36	M 8
170	172	206	-	-	2	17	30 x 30 x 3	9,5	1,36	M 8
180	182	216	-	-	2	17	30 x 30 x 3	9,5	1,36	M 8
190	192	226	-	-	2	17	30 x 30 x 3	9,5	1,36	M 8
200	202	236	-	-	2	17	30 x 30 x 3	9,5	1,36	M 8
212	214	248	-	-	2	17	30 x 30 x 3	9,5	1,36	M 8
224	226	260	-	-	2	17	30 x 30 x 3	9,5	1,36	M 8
236	238	272	-	-	2	17	30 x 30 x 3	9,5	1,36	M 8
250	252	286	-	-	2	17	30 x 30 x 3	9,5	1,36	M 8
265	267	301	150,5	-	3	17	30 x 30 x 3	9,5	1,36	M 8
280	282	316	158	-	3	17	30 x 30 x 3	9,5	1,36	M 8
300	302	336	168	-	3	17	30 x 30 x 3	9,5	1,36	M 8
315	317	351	175,5	-	3	17	30 x 30 x 3	9,5	1,36	M 8
335	337	371	185,5	-	3	17	30 x 30 x 3	9,5	1,36	M 8
355	357	391	195,5	-	3	17	30 x 30 x 3	9,5	1,36	M 8
375	377	411	205,5	-	3	17	30 x 30 x 3	9,5	1,36	M 8
400	402	436	218	-	3	17	30 x 30 x 3	9,5	1,36	M 8
425	427	461	230,5	-	3	17	30 x 30 x 3	9,5	1,36	M 8
450	452	486	243	-	3	17	30 x 30 x 3	9,5	1,36	M 8
475	477	511	255,5	-	3	17	30 x 30 x 3	9,5	1,36	M 8

All measurements are in millimetres and weights in kg.

DIN24193 - Annex 1

February 1988 Issue

Rectangular and square flanges for HVAC systems

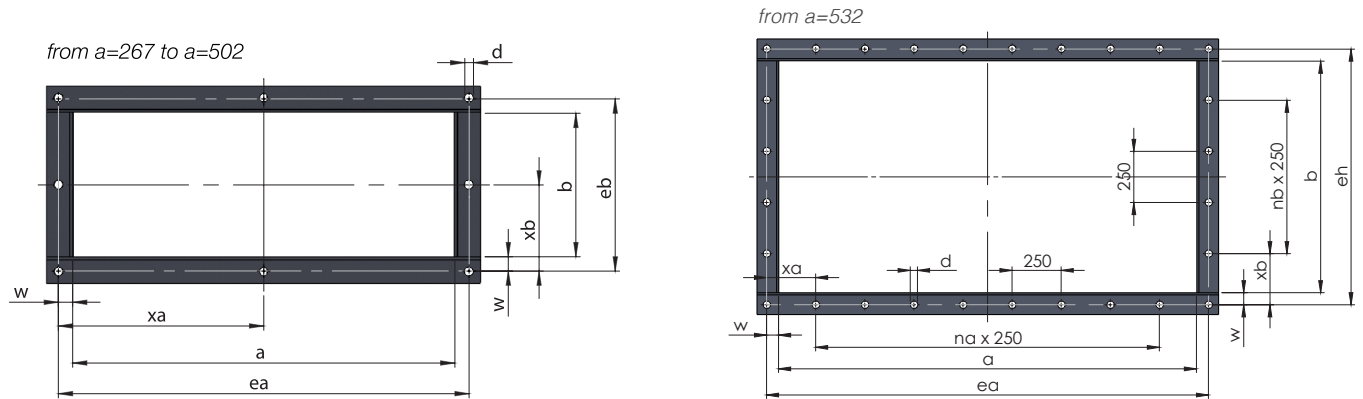

DN Nominal Size	Inside Width / Length a / b	ea / eb	xa / xb	Divisor na / nb	N° of Bolt Holes nea / neb	Mark Out Line w	Angle Steel c x c x s	Bolt Hole Diameter d	Weight kg/m	Bolts
500	502	536	268	-	3	17	30 x 30 x 3	9,5	1,36	M 8
530	532	566	158	1	4	17	30 x 30 x 3	9,5	1,36	M 8
560	562	596	173	1	4	17	30 x 30 x 3	9,5	1,36	M 8
600	602	636	193	1	4	17	30 x 30 x 3	9,5	1,36	M 8
630	632	666	208	1	4	17	30 x 30 x 3	9,5	1,36	M 8
670	672	706	228	1	4	17	30 x 30 x 3	9,5	1,36	M 8
710	712	746	248	1	4	17	30 x 30 x 3	9,5	1,36	M 8
750	752	786	268	1	4	17	30 x 30 x 3	9,5	1,36	M 8
800	802	836	43	3	6	17	30 x 30 x 3	9,5	1,36	M 8
850	852	886	68	3	6	17	30 x 30 x 3	9,5	1,36	M 8
900	902	936	93	3	6	17	30 x 30 x 3	9,5	1,36	M 8
950	952	986	118	3	6	17	30 x 30 x 3	9,5	1,36	M 8
1000	1002	1036	143	3	6	17	30 x 30 x 3	9,5	1,36	M 8
1060	1062	1096	173	3	6	17	30 x 30 x 3	9,5	1,36	M 8
1120	1122	1156	203	3	6	17	30 x 30 x 3	9,5	1,36	M 8
1180	1182	1216	233	3	6	17	30 x 30 x 3	9,5	1,36	M 8
1250	1252	1286	268	3	6	17	30 x 30 x 3	9,5	1,36	M 8
1320	1322	1366	58	5	8	22	40 x 40 x 4	9,5	2,42	M 8
1400	1402	1446	98	5	8	22	40 x 40 x 4	9,5	2,42	M 8
1500	1502	1546	148	5	8	22	40 x 40 x 4	9,5	2,42	M 8
1600	1602	1646	198	5	8	22	40 x 40 x 4	9,5	2,42	M 8
1700	1702	1746	248	5	8	22	40 x 40 x 4	9,5	2,42	M 8
1800	1802	1846	48	7	10	22	40 x 40 x 4	9,5	2,42	M 8
1900	1902	1946	98	7	10	22	40 x 40 x 4	9,5	2,42	M 8
2000	2002	2046	148	7	10	22	40 x 40 x 4	9,5	2,42	M 8
2120	2122	2166	208	7	10	22	40 x 40 x 4	9,5	2,42	M 8
2240	2242	2286	268	7	10	22	40 x 40 x 4	9,5	2,42	M 8
2360	2362	2406	78	9	12	22	40 x 40 x 4	9,5	2,42	M 8
2500	2502	2546	148	9	12	22	40 x 40 x 4	9,5	2,42	M 8

All measurements are in millimetres and weights in kg.

DIN24193 - Annex 2

February 1988 Issue

Rectangular and square flanges for HVAC systems

Material

1.0038 mild & galvanized steel

1.4301, 1.4571

further materials on request



Form FL

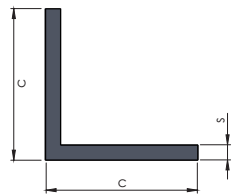

Form L

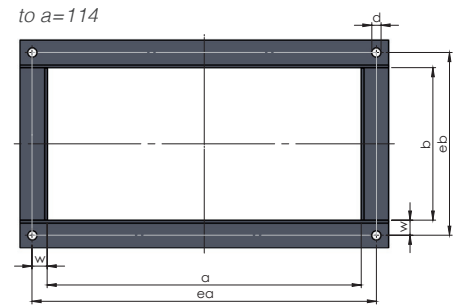

DN Nominal Size	Inside Width / Length a / b	ea / eb	xa / xb	Divisor na / nb	N° of Bolt Holes nea / neb	Mark Out Line w	Flat Steel DIN1017 c x s	Weight kg/m	Angle Steel DIN1028 c x c x s	Weight kg/m	Bolt Hole Diameter d	Bolts
100	102	136	-	-	2	17	30 x 5	1,18	30 x 30 x 3	1,36	10	M 8
106	108	142	-	-	2	17	30 x 5	1,18	30 x 30 x 3	1,36	10	M 8
112	114	148	-	-	2	17	30 x 5	1,18	30 x 30 x 3	1,36	10	M 8
118	120	154	77	-	3	17	30 x 5	1,18	30 x 30 x 3	1,36	10	M 8
125	127	161	80,5	-	3	17	30 x 5	1,18	30 x 30 x 3	1,36	10	M 8
132	134	168	84	-	3	17	30 x 5	1,18	30 x 30 x 3	1,36	10	M 8
140	142	176	88	-	3	17	30 x 5	1,18	30 x 30 x 3	1,36	10	M 8
150	152	186	93	-	3	17	30 x 5	1,18	30 x 30 x 3	1,36	10	M 8
160	162	196	98	-	3	17	30 x 5	1,18	30 x 30 x 3	1,36	10	M 8
170	172	206	103	-	3	17	30 x 5	1,18	30 x 30 x 3	1,36	10	M 8
180	182	216	108	-	3	17	30 x 5	1,18	30 x 30 x 3	1,36	10	M 8
190	192	226	113	-	3	17	30 x 5	1,18	30 x 30 x 3	1,36	10	M 8
200	202	236	118	-	3	17	30 x 5	1,18	30 x 30 x 3	1,36	10	M 8
212	214	248	124	-	3	17	30 x 5	1,18	30 x 30 x 3	1,36	10	M 8
224	226	260	130	-	3	17	30 x 5	1,18	30 x 30 x 3	1,36	10	M 8
236	238	272	136	-	3	17	30 x 5	1,18	30 x 30 x 3	1,36	10	M 8
250	252	286	143	-	3	17	30 x 5	1,18	30 x 30 x 3	1,36	10	M 8
265	267	301	150,5	-	3	17	30 x 5	1,18	30 x 30 x 3	1,36	10	M 8
280	282	316	158	-	3	17	30 x 5	1,18	30 x 30 x 3	1,36	10	M 8
300	302	336	105,5	1	4	17	30 x 5	1,18	30 x 30 x 3	1,36	10	M 8
315	317	351	113	1	4	17	30 x 5	1,18	30 x 30 x 3	1,36	10	M 8
335	337	371	123	1	4	17	30 x 5	1,18	30 x 30 x 3	1,36	10	M 8
355	357	391	133	1	4	17	30 x 5	1,18	30 x 30 x 3	1,36	10	M 8
375	377	411	143	1	4	17	30 x 5	1,18	30 x 30 x 3	1,36	10	M 8
400	402	436	155,5	1	4	17	30 x 5	1,18	30 x 30 x 3	1,36	10	M 8
425	427	461	168	1	4	17	30 x 5	1,18	30 x 30 x 3	1,36	10	M 8
450	452	496	60,5	3	6	22	40 x 5	1,57	40 x 40 x 4	2,42	12	M 10
475	477	521	73	3	6	22	40 x 5	1,57	40 x 40 x 4	2,42	12	M 10
500	502	546	85,5	3	6	22	40 x 5	1,57	40 x 40 x 4	2,42	12	M 10
530	532	576	100,5	3	6	22	40 x 5	1,57	40 x 40 x 4	2,42	12	M 10

All measurements are in millimetres and weights in kg.

DIN24193 - Annex 2

February 1988 Issue

Rectangular and square flanges for HVAC systems

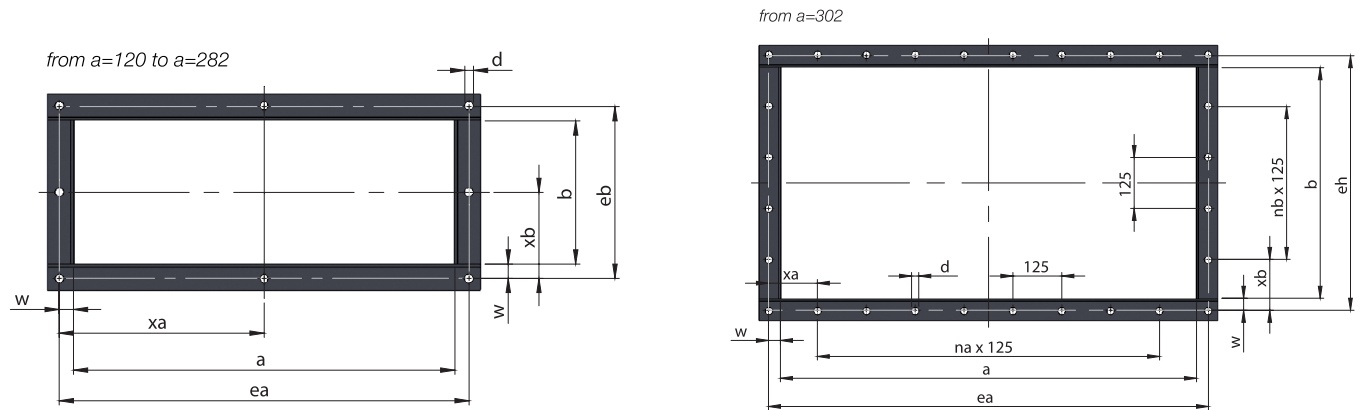

DN Nominal Size	Inside Width / Length a / b	ea / eb	xa / xb	Divisor na / nb	N° of Bolt Holes nea / neb	Mark Out Line w	Flat Steel DIN1017 c x s	Weight kg/m	Angle Steel DIN1028 c x c x s	Weight kg/m	Bolt Hole Diameter d	Bolts
560	562	606	115,5	3	6	22	40 x 5	1,57	40 x 40 x 4	2,42	12	M 10
600	602	646	135,5	3	6	22	40 x 5	1,57	40 x 40 x 4	2,42	12	M 10
630	632	676	150,5	3	6	22	40 x 5	1,57	40 x 40 x 4	2,42	12	M 10
670	672	716	170,5	3	6	22	40 x 5	1,57	40 x 40 x 4	2,42	12	M 10
710	712	756	65,5	5	8	22	40 x 5	1,57	40 x 40 x 4	2,42	12	M 10
750	752	796	85,5	5	8	22	40 x 5	1,57	40 x 40 x 4	2,42	12	M 10
800	802	846	110,5	5	8	22	40 x 5	1,57	40 x 40 x 4	2,42	12	M 10
850	852	896	135,5	5	8	22	40 x 5	1,57	40 x 40 x 4	2,42	12	M 10
900	902	946	160,5	5	8	22	40 x 5	1,57	40 x 40 x 4	2,42	12	M 10
950	952	996	60,5	7	10	22	40 x 5	1,57	40 x 40 x 4	2,42	12	M 10
1000	1002	1046	85,5	7	10	22	40 x 5	1,57	40 x 40 x 4	2,42	12	M 10
1060	1062	1132	128,5	7	10	35	60 x 6	2,83	60 x 60 x 6	5,42	12	M 10
1120	1122	1192	158,5	7	10	35	60 x 6	2,83	60 x 60 x 6	5,42	12	M 10
1180	1182	1252	188,5	7	10	35	60 x 6	2,83	60 x 60 x 6	5,42	12	M 10
1250	1252	1322	98,5	9	12	35	60 x 6	2,83	60 x 60 x 6	5,42	12	M 10
1320	1322	1392	133,5	9	12	35	60 x 6	2,83	60 x 60 x 6	5,42	12	M 10
1400	1402	1472	173,5	9	12	35	60 x 6	2,83	60 x 60 x 6	5,42	12	M 10
1500	1502	1572	98,5	11	14	35	60 x 6	2,83	60 x 60 x 6	5,42	12	M 10
1600	1602	1672	148,5	11	14	35	60 x 6	2,83	60 x 60 x 6	5,42	12	M 10
1700	1702	1772	73,5	13	16	35	60 x 6	2,83	60 x 60 x 6	5,42	12	M 10
1800	1802	1872	123,5	13	16	35	60 x 6	2,83	60 x 60 x 6	5,42	12	M 10
1900	1902	1972	173,5	13	16	35	60 x 6	2,83	60 x 60 x 6	5,42	12	M 10
2000	2002	2072	98,5	15	18	35	60 x 10	4,71	60 x 60 x 8	7,09	12	M 10
2120	2122	2192	158,5	15	18	35	60 x 10	4,71	60 x 60 x 8	7,09	12	M 10
2240	2242	2312	93,5	17	20	35	60 x 10	4,71	60 x 60 x 8	7,09	12	M 10
2360	2362	2452	163,5	17	20	45	80 x 10	6,28	80 x 80 x 8	9,66	15	M 12
2500	2502	2592	108,5	19	22	45	80 x 10	6,28	80 x 80 x 8	9,66	15	M 12
2650	2652	2742	183,5	19	22	45	80 x 10	6,28	80 x 80 x 8	9,66	15	M 12
2800	2802	2892	133,5	21	24	45	80 x 12	7,54	80 x 80 x 10	11,90	15	M 12
3000	3002	3092	108,5	23	26	45	80 x 12	7,54	80 x 80 x 10	11,90	15	M 12

All measurements are in millimetres and weights in kg.

For stainless steel materials, the material thickness s deviates from the DIN.

DIN24193 - Annex 3

February 1988 Issue

Rectangular and square flanges for HVAC systems

Material

1.0038 mild & galvanized steel

1.4301, 1.4571

further materials on request



Form FL

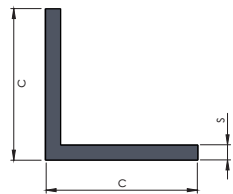

Form L

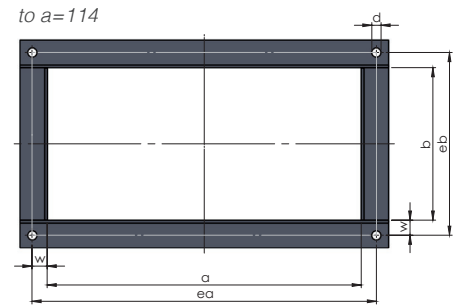

DN Nominal Size	Inside Width / Length a/b	ea / eb	xa / xb	Divisor na / nb	N° of Bolt Holes nea / neb	Mark Out Line w	Flat Steel DIN1017 c x s	Weight kg/m	Angle Steel DIN1028 c x c x s	Weight kg/m	Bolt Hole Diameter d	Bolts
100	102	136	-	-	2	17	30 x 5	1,18	30 x 30 x 3	1,36	10	M 8
106	108	142	-	-	2	17	30 x 5	1,18	30 x 30 x 3	1,36	10	M 8
112	114	148	-	-	2	17	30 x 5	1,18	30 x 30 x 3	1,36	10	M 8
118	120	154	77	-	3	17	30 x 5	1,18	30 x 30 x 3	1,36	10	M 8
125	127	161	80,5	-	3	17	30 x 5	1,18	30 x 30 x 3	1,36	10	M 8
132	134	168	84	-	3	17	30 x 5	1,18	30 x 30 x 3	1,36	10	M 8
140	142	176	88	-	3	17	30 x 5	1,18	30 x 30 x 3	1,36	10	M 8
150	152	186	93	-	3	17	30 x 5	1,18	30 x 30 x 3	1,36	10	M 8
160	162	196	98	-	3	17	30 x 5	1,18	30 x 30 x 3	1,36	10	M 8
170	172	206	103	-	3	17	30 x 5	1,18	30 x 30 x 3	1,36	10	M 8
180	182	216	108	-	3	17	30 x 5	1,18	30 x 30 x 3	1,36	10	M 8
190	192	226	113	-	3	17	30 x 5	1,18	30 x 30 x 3	1,36	10	M 8
200	202	236	118	-	3	17	30 x 5	1,18	30 x 30 x 3	1,36	10	M 8
212	214	248	124	-	3	17	30 x 5	1,18	30 x 30 x 3	1,36	10	M 8
224	226	260	130	-	3	17	30 x 5	1,18	30 x 30 x 3	1,36	10	M 8
236	238	272	136	-	3	17	30 x 5	1,18	30 x 30 x 3	1,36	10	M 8
250	252	286	143	-	3	17	30 x 5	1,18	30 x 30 x 3	1,36	10	M 8
265	267	301	150,5	-	3	17	30 x 5	1,18	30 x 30 x 3	1,36	10	M 8
280	282	316	158	-	3	17	30 x 5	1,18	30 x 30 x 3	1,36	10	M 8
300	302	336	105,5	1	4	17	30 x 5	1,18	30 x 30 x 3	1,36	10	M 8
315	317	351	113	1	4	17	30 x 5	1,18	30 x 30 x 3	1,36	10	M 8
335	337	371	123	1	4	17	30 x 5	1,18	30 x 30 x 3	1,36	10	M 8
355	357	391	133	1	4	17	30 x 5	1,18	30 x 30 x 3	1,36	10	M 8
375	377	411	143	1	4	17	30 x 5	1,18	30 x 30 x 3	1,36	10	M 8
400	402	436	155,5	1	4	17	30 x 5	1,18	30 x 30 x 3	1,36	10	M 8
425	427	461	168	1	4	17	30 x 5	1,18	30 x 30 x 3	1,36	10	M 8
450	452	512	68,5	3	6	30	50 x 5	1,96	50 x 50 x 5	3,77	15	M 12
475	477	537	81	3	6	30	50 x 5	1,96	50 x 50 x 5	3,77	15	M 12
500	502	562	93,5	3	6	30	50 x 5	1,96	50 x 50 x 5	3,77	15	M 12
530	532	592	108,5	3	6	30	50 x 5	1,96	50 x 50 x 5	3,77	15	M 12

All measurements are in millimetres and weights in kg.

DIN24193 - Annex 3

February 1988 Issue

Rectangular and square flanges for HVAC systems

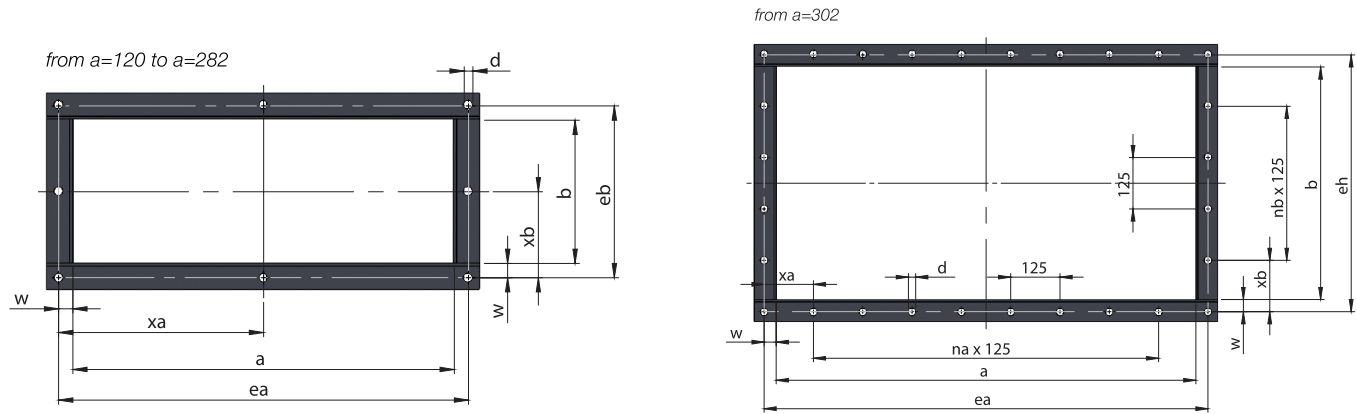

DN Nominal Size	Inside Width / Length a / b	ea / eb	xa / xb	Divisor na / nb	N° of Bolt Holes nea / neb	Mark Out Line w	Flat Steel DIN1017 c x s	Weight kg/m	Angle Steel DIN1028 c x c x s	Weight kg/m	Bolt Hole Diameter d	Bolts
560	562	622	123,5	3	6	30	50 x 5	1,96	50 x 50 x 5	3,77	15	M 12
600	602	662	143,5	3	6	30	50 x 5	1,96	50 x 50 x 5	3,77	15	M 12
630	632	692	158,5	3	6	30	50 x 5	1,96	50 x 50 x 5	3,77	15	M 12
670	672	732	178,5	3	6	30	50 x 5	1,96	50 x 50 x 5	3,77	15	M 12
710	712	772	73,5	5	8	30	50 x 5	1,96	50 x 50 x 5	3,77	15	M 12
750	752	812	93,5	5	8	30	50 x 5	1,96	50 x 50 x 5	3,77	15	M 12
800	802	862	118,5	5	8	30	50 x 5	1,96	50 x 50 x 5	3,77	15	M 12
850	852	912	143,5	5	8	30	50 x 5	1,96	50 x 50 x 5	3,77	15	M 12
900	902	962	168,5	5	8	30	50 x 5	1,96	50 x 50 x 5	3,77	15	M 12
950	952	1012	68,5	7	10	30	50 x 5	1,96	50 x 50 x 5	3,77	15	M 12
1000	1002	1062	93,5	7	10	30	50 x 5	1,96	50 x 50 x 5	3,77	15	M 12
1060	1062	1132	128,5	7	10	35	60 x 6	2,83	60 x 60 x 6	5,42	19	M 16
1120	1122	1192	158,5	7	10	35	60 x 6	2,83	60 x 60 x 6	5,42	19	M 16
1180	1182	1252	188,5	7	10	35	60 x 6	2,83	60 x 60 x 6	5,42	19	M 16
1250	1252	1322	98,5	9	12	35	60 x 6	2,83	60 x 60 x 6	5,42	19	M 16
1320	1322	1392	133,5	9	12	35	60 x 6	2,83	60 x 60 x 6	5,42	19	M 16
1400	1402	1472	173,5	9	12	35	60 x 6	2,83	60 x 60 x 6	5,42	19	M 16
1500	1502	1572	98,5	11	14	35	60 x 6	2,83	60 x 60 x 6	5,42	19	M 16
1600	1602	1692	158,5	11	14	45	80 x 10	6,28	80 x 80 x 6	7,34	24	M 20
1700	1702	1792	83,5	13	16	45	80 x 10	6,28	80 x 80 x 6	7,34	24	M 20
1800	1802	1892	133,5	13	16	45	80 x 10	6,28	80 x 80 x 6	7,34	24	M 20
1900	1902	1992	183,5	13	16	45	80 x 10	6,28	80 x 80 x 6	7,34	24	M 20
2000	2002	2092	108,5	15	18	45	80 x 10	6,28	80 x 80 x 6	7,34	24	M 20
2120	2122	2212	168,5	15	18	45	80 x 12	7,54	80 x 80 x 8	9,66	24	M 20
2240	2242	2332	103,5	17	20	45	80 x 12	7,54	80 x 80 x 8	9,66	24	M 20
2360	2362	2472	173,5	17	20	55	100 x 15	11,8	100 x 100 x 10	15,10	24	M 20
2500	2502	2612	118,5	19	22	55	100 x 15	11,8	100 x 100 x 10	15,10	24	M 20
2650	2652	2762	193,5	19	22	55	100 x 15	11,8	100 x 100 x 10	15,10	24	M 20
2800	2802	2912	143,5	21	24	55	100 x 20	15,7	100 x 100 x 12	17,80	24	M 20
3000	3002	3112	118,5	23	26	55	100 x 20	15,7	100 x 100 x 12	17,80	24	M 20

All measurements are in millimetres and weights in kg.

For stainless steel materials, the material thickness s deviates from the DIN.



ESKATE® SAFE & SOLID CLAMPING RING

Stability, Security and Speed

for 1, 2 and 3mm ducting (DIN24151 and similar) for use with rim seals

The ESKATE® SAFE & SOLID clamping ring combines the utmost security with rapid assembly and is your first choice if you place great emphasis on stability, security and speed. It boasts a particularly large contact face with the pipe and thus aligns the pipe's ends. This guarantees flawless utility performance at the pipe's connection points. Additional gas-shielded welding makes the SAFE & SOLID even more secure.

When combined with our edge seal it is certified as explosion-resistant for the following nominal dimensions:

- > DN 100–400mm with 4,5 bar
- > DN 450–630mm with 1,5 bar

In addition, the SAFE & SOLID can be supplied with a safety catch that secures the closure against unintentional opening. Thus the clamping ring offers even more security. Last but not least, thanks to its rapid closure, the SAFE & SOLID is very quick and easy to assemble on the duct, and quick to release too. The ESKATE® SAFE & SOLID is available in sizes DN 100 – 630mm from stock. Larger diameters and sizes in-between are available on request.

CLAMPING RINGS

As a system supplier for clamping ring solutions we manufacture both standard and non-standard versions. Mass production and customer-specific piece production are easy, quick and affordable for us to carry out. We stockpile common standard dimensions and versions, as well as customer-specific factory standards, in galvanic and blasted stainless steel versions so they are available to you on call.

Special clamping rings and factory standards

What makes us stand out from the crowd is our skill in designing and manufacturing bespoke clamping ring solutions in non-standard sizes. Factory standards, sizes in-between or other bespoke designs are a common sight in our production facility.

The versatility of clamping rings in a wide range of applications has, over the last 30 years, led to the development of numerous factory standards and bespoke designs. Since each area of application is different, our draughtsmen start work early, during the design phase, on a suitable and secure clamping ring profile. This includes among others profiles for ducts with rounded rims. Our project planning ensures reliable procedures whether one-off or mass production of your products.

EACH AND EVERY TYPE OF ESKATE® CLAMPING RING CAN BE MANUFACTURED FOR YOU, IN YOUR PARTICULAR SIZE.



CLAMPING RINGS

For ducts and piping in accordance with DIN24151 and similar types

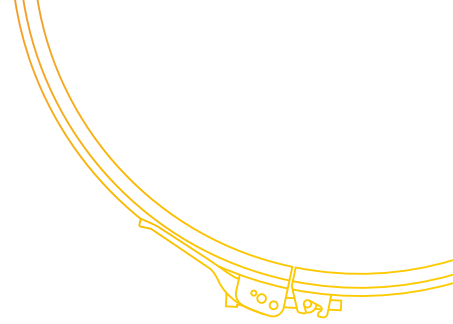

Clamping ring 1-part for 1mm systems

This clamping ring type with integrated sealing insert is a simple and affordable connection for the 1mm duct systems.



Clamping ring 2-part for 1, 2 and 3mm ducting

The two-part clamping ring **with factory fitted sealing insert** is manufactured in **3 different profile versions**. This clamping ring is, thanks to its unique swivel joint latch, particularly easy to assemble even in hard to reach places and is as such quick and easy to use.



Clamping Ring for longitudinal and spiral ducting

The duct clamping ring has been designed for connecting spiral ducting with a rim width of 4-6mm. This clamp is equally suitable for longitudinally welded or crimped seams. The very wide, profiled strap gives ample coverage of the crimped seam. The ESKATE® double-clasp ensures both arms are tightly and evenly secured.



Clamping ring 2-part with rim seal

This clamping ring type, used with a rim seal, is provided in a version suitable for three wall thicknesses. This profile combined with a rim seal is suitable for connections of 1, 2 and 3mm ducting and, as such, is universally suitable. Wall thickness compensation is achieved by the rim seal. This clamping ring is, thanks to its unique swivel joint latch, particularly easy to assemble and guarantees explosion pressure shock resistance up to three bar.



ESKATE® Rim Seal Quick-Close Clamping Ring

This clamping ring type, used with a rim seal, is provided in a version suitable for three wall thicknesses. This profile combined with a rim seal is suitable for connections of 1, 2 and 3mm ducting and, as such, is universally useable. The characteristic, three-part hinge and quick latch mechanism of this clamp make it extraordinarily installation friendly.



ESKATE® SAFE & SOLID Rim Seal Clamping Ring

The SAFE & SOLID clamping ring used together with a rim seal is manufactured in a profile design. This profile combined with a rim seal is suitable for 1, 2 and 3mm piping and, as such, is universally useable. The SAFE & SOLID clamping ring is leakage proof, dependable and highly secure, this is further emphasized by a supplemental safety catch. The eminently installation-friendly swivel joint design makes it ideal for use in those difficult to reach places.

Safe & Solid Clamping Ring with Safety Catch

for use with rim seal for connecting
1, 2 & 3mm wall thicknesses

Material

1.0038 galvanized
1.4301 stainless steel
Additional materials and
diameters on request

Profile



Supplemental safety catch
provides enhanced safety.

Certified explosion pressure shock proof for:
DN 100–400mm with 4,5 bar
DN 450–630mm with 1,5 bar



DN Nominal Diameter	Inside Diameter A	Bolt DIN912	Material Thickness	Weight	Part N°	
					1.0038 galvanized	1.4301 stainless
100	106	M8 x 60	2	0,432	SS-100	SS-100-01
112	118	M8 x 60	2	0,450	SS-112	SS-112-01
120	126	M8 x 60	2	0,463	SS-120	SS-120-01
125	131	M8 x 60	2	0,470	SS-125	SS-125-01
140	146	M8 x 60	2	0,493	SS-140	SS-140-01
150	156	M8 x 60	2	0,508	SS-150	SS-150-01
160	166	M8 x 60	2	0,523	SS-160	SS-160-01
175	181	M8 x 60	2	0,546	SS-175	SS-175-01
180	186	M8 x 60	2	0,554	SS-180	SS-180-01
200	206	M8 x 60	2	0,592	SS-200	SS-200-01
224	230	M8 x 60	2	0,629	SS-224	SS-224-01
250	256	M8 x 60	2	0,668	SS-250	SS-250-01
280	286	M8 x 60	2	0,714	SS-280	SS-280-01
300	306	M8 x 60	2	0,744	SS-300	SS-300-01
315	321	M8 x 60	2	0,767	SS-315	SS-315-01
350	356	M8 x 60	2	0,820	SS-350	SS-350-01
355	361	M8 x 60	2	0,828	SS-355	SS-355-01
400	406	M8 x 60	2	0,896	SS-400	SS-400-01
450	456	M8 x 60	2	0,989	SS-450	SS-450-01
500	506	M8 x 60	2	1,065	SS-500	SS-500-01
550	556	M8 x 60	2	1,141	SS-550	SS-550-01
560	566	M8 x 60	2	1,156	SS-560	SS-560-01
600	606	M8 x 60	2	1,217	SS-600	SS-600-01
630	636	M8 x 60	2	1,262	SS-630	SS-630-01

All measurements are in millimetres and weights in kg.

Safe & Solid Clamping Ring without Safety Catch

for use with rim seal for connecting
1, 2 & 3mm wall thicknesses

Material

1.0038 galvanized
1.4301 stainless steel
Additional materials and
diameters on request

Profile



Certified explosion pressure shock proof for:
DN 100–400mm with 4,5 bar
DN 450–630mm with 1,5 bar



DN Nominal Diameter	Inside Diameter A	Bolt DIN912	Material Thickness	Weight	Part N°	
					1.0038 galvanized	1.4301 stainless
100	106	M8 x 60	2	0,429	SS-100-BG	SS-100-01-BG
112	118	M8 x 60	2	0,447	SS-112-BG	SS-112-01-BG
120	126	M8 x 60	2	0,460	SS-120-BG	SS-120-01-BG
125	131	M8 x 60	2	0,467	SS-125-BG	SS-125-01-BG
140	146	M8 x 60	2	0,490	SS-140-BG	SS-140-01-BG
150	156	M8 x 60	2	0,505	SS-150-BG	SS-150-01-BG
160	166	M8 x 60	2	0,520	SS-160-BG	SS-160-01-BG
175	181	M8 x 60	2	0,543	SS-175-BG	SS-175-01-BG
180	186	M8 x 60	2	0,551	SS-180-BG	SS-180-01-BG
200	206	M8 x 60	2	0,589	SS-200-BG	SS-200-01-BG
224	230	M8 x 60	2	0,626	SS-224-BG	SS-224-01-BG
250	256	M8 x 60	2	0,665	SS-250-BG	SS-250-01-BG
280	286	M8 x 60	2	0,711	SS-280-BG	SS-280-01-BG
300	306	M8 x 60	2	0,741	SS-300-BG	SS-300-01-BG
315	321	M8 x 60	2	0,764	SS-315-BG	SS-315-01-BG
350	356	M8 x 60	2	0,817	SS-350-BG	SS-350-01-BG
355	361	M8 x 60	2	0,825	SS-355-BG	SS-355-01-BG
400	406	M8 x 60	2	0,893	SS-400-BG	SS-400-01-BG
450	456	M8 x 60	2	0,986	SS-450-BG	SS-450-01-BG
500	506	M8 x 60	2	1,062	SS-500-BG	SS-500-01-BG
550	556	M8 x 60	2	1,138	SS-550-BG	SS-550-01-BG
560	566	M8 x 60	2	1,153	SS-560-BG	SS-560-01-BG
600	606	M8 x 60	2	1,214	SS-600-BG	SS-600-01-BG
630	636	M8 x 60	2	1,259	SS-630-BG	SS-630-01-BG

All measurements are in millimetres and weights in kg.

Quick-Latch Clamping Ring

for use with rim seal for connecting
1, 2 & 3mm wall thicknesses

Material

1.0038 galvanized
1.4301 stainless steel
Additional materials and
diameters on request

Profile



Explosion pressure shock proof up to 3 bar



DN Nominal Diameter	Inside Diameter A	Bolt DIN912	Material Thickness		Weight	Part N°	
			1.0038	1.4301		1.0038 galvanized	1.4301 stainless
80	86	M6 x 60	1,50	1,50	0,247	SB-80	SB-80-01
90	96	M6 x 60	1,50	1,50	0,254	SB-90	SB-90-01
100	106	M6 x 60	2,00	1,75	0,306	SB-100	SB-100-01
112	118	M6 x 60	2,00	1,75	0,320	SB-112	SB-112-01
120	126	M6 x 60	2,00	1,75	0,329	SB-120	SB-120-01
125	131	M6 x 60	2,00	1,75	0,335	SB-125	SB-125-01
140	146	M6 x 60	2,00	1,75	0,353	SB-140	SB-140-01
150	156	M6 x 60	2,00	1,75	0,364	SB-150	SB-150-01
160	166	M6 x 60	2,00	1,75	0,376	SB-160	SB-160-01
175	181	M6 x 60	2,00	1,75	0,393	SB-175	SB-175-01
180	186	M6 x 60	2,00	1,75	0,399	SB-180	SB-180-01
200	206	M6 x 60	2,00	1,75	0,423	SB-200	SB-200-01
224	230	M6 x 60	2,00	1,75	0,450	SB-224	SB-224-01
250	256	M6 x 60	2,00	1,75	0,481	SB-250	SB-250-01
280	286	M6 x 60	2,00	1,75	0,516	SB-280	SB-280-01
300	306	M6 x 60	2,00	1,75	0,539	SB-300	SB-300-01
315	321	M6 x 60	2,00	1,75	0,557	SB-315	SB-315-01
350	356	M6 x 60	2,00	1,75	0,597	SB-350	SB-350-01
355	361	M6 x 60	2,00	1,75	0,603	SB-355	SB-355-01
400	406	M6 x 60	2,00	1,75	0,656	SB-400	SB-400-01
450	456	M6 x 60	2,00	1,75	0,714	SB-450	SB-450-01
500	506	M6 x 60	2,00	1,75	0,772	SB-500	SB-500-01
550	556	M6 x 60	2,00	1,75	0,831	SB-550	SB-550-01
560	566	M6 x 60	2,00	1,75	0,842	SB-560	SB-560-01
600	606	M6 x 60	2,00	1,75	0,889	SB-600	SB-600-01
630	636	M6 x 60	2,00	1,75	0,924	SB-630	SB-630-01

All measurements are in millimetres and weights in kg.

Two-Part Clamping Ring

for use with rim seal for connecting
1, 2 & 3mm wall thicknesses

Material

1.0038 galvanized
1.4301 stainless steel
Additional materials and
diameters on request

Profile



Explosion pressure shock proof up to 3 bar



DN Nominal Diameter	Inside Diameter A	Bolt DIN912	Material Thickness		Weight	Part N°	
			1.0038	1.4301		1.0038 galvanized	1.4301 stainless
80	86	M8 x 60	1,50	1,50	0,247	2B-80	2B-80-01
90	96	M8 x 60	1,50	1,50	0,254	2B-90	2B-90-01
100	106	M8 x 60	2,00	1,75	0,306	2B-100	2B-100-01
112	118	M8 x 60	2,00	1,75	0,320	2B-112	2B-112-01
120	126	M8 x 60	2,00	1,75	0,329	2B-120	2B-120-01
125	131	M8 x 60	2,00	1,75	0,335	2B-125	2B-125-01
140	146	M8 x 60	2,00	1,75	0,353	2B-140	2B-140-01
150	156	M8 x 60	2,00	1,75	0,364	2B-150	2B-150-01
160	166	M8 x 60	2,00	1,75	0,376	2B-160	2B-160-01
175	181	M8 x 60	2,00	1,75	0,393	2B-175	2B-175-01
180	186	M8 x 60	2,00	1,75	0,399	2B-180	2B-180-01
200	206	M8 x 60	2,00	1,75	0,423	2B-200	2B-200-01
224	230	M8 x 60	2,00	1,75	0,450	2B-224	2B-224-01
250	256	M8 x 60	2,00	1,75	0,481	2B-250	2B-250-01
280	286	M8 x 60	2,00	1,75	0,516	2B-280	2B-280-01
300	306	M8 x 60	2,00	1,75	0,539	2B-300	2B-300-01
315	321	M8 x 60	2,00	1,75	0,557	2B-315	2B-315-01
350	356	M8 x 60	2,00	1,75	0,597	2B-350	2B-350-01
355	361	M8 x 60	2,00	1,75	0,603	2B-355	2B-355-01
400	406	M8 x 60	2,00	1,75	0,656	2B-400	2B-400-01
450	456	M8 x 60	2,00	1,75	0,714	2B-450	2B-450-01
500	506	M8 x 60	2,00	1,75	0,772	2B-500	2B-500-01
550	556	M8 x 60	2,00	1,75	0,831	2B-550	2B-550-01
560	566	M8 x 60	2,00	1,75	0,842	2B-560	2B-560-01
600	606	M8 x 60	2,00	1,75	0,889	2B-600	2B-600-01
630	636	M8 x 60	2,00	1,75	0,924	2B-630	2B-630-01

All measurements are in millimetres and weights in kg.

Rim Seals

made of NBR/Perbunan, conductive
for use with clamping rings and wall thicknesses of 1, 2 & 3mm

Properties	
Colour	black
Heat Resistance	-40°C to +130°C
Suitable for use with	Hydrogen Chlorides, Ammoniac, Heptane, Pentane, organic and mineral oils and greases and foodstuffs
Unsuitable for use with	Acetone, weathering, Methyl Ethyl Ketone, Ozone and acids

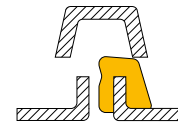

1mm pipework

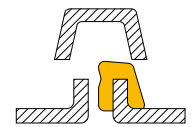

2mm pipework

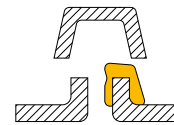

3mm pipework



sealed state

DN Nominal Diameter	Part N° 1mm Wall Thickness	Part N° 2mm Wall Thickness	Part N° 3mm Wall Thickness
80	PL-80-1	PL-80-2	PL-80-3
90	PL-90-1	PL-90-2	PL-90-3
100	PL-100-1	PL-100-2	PL-100-3
112	PL-112-1	PL-112-2	PL-112-3
120	PL-120-1	PL-120-2	PL-120-3
125	PL-125-1	PL-125-2	PL-125-3
140	PL-140-1	PL-140-2	PL-140-3
150	PL-150-1	PL-150-2	PL-150-3
160	PL-160-1	PL-160-2	PL-160-3
175	PL-175-1	PL-175-2	PL-175-3
180	PL-180-1	PL-180-2	PL-180-3
200	PL-200-1	PL-200-2	PL-200-3
224	PL-224-1	PL-224-2	PL-224-3
250	PL-250-1	PL-250-2	PL-250-3
280	PL-280-1	PL-280-2	PL-280-3
300	PL-300-1	PL-300-2	PL-300-3
315	PL-315-1	PL-315-2	PL-315-3
350	PL-350-1	PL-350-2	PL-350-3
355	PL-355-1	PL-355-2	PL-355-3
400	PL-400-1	PL-400-2	PL-400-3
450	PL-450-1	PL-450-2	PL-450-3
500	PL-500-1	PL-500-2	PL-500-3
550	PL-550-1	PL-550-2	PL-550-3
560	PL-560-1	PL-560-2	PL-560-3
600	PL-600-1	PL-600-2	PL-600-3
630	PL-630-1	PL-630-2	PL-630-3

All measurements are in millimetres.

Special sizes on request

Rim Seals

made of silicone, conform to FDA, non-conductive
for use with clamping rings and wall thicknesses of 1, 2 & 3mm

Properties	
Colour	transparent
Heat Resistance	-60°C to +200°C (briefly 250°C)
Suitable for use with	Water/ Steam (to 120°C), Acetone, Ammonia (in gas and in water), Ozone, many organic oils and grea- ses, Alkalis, foodstuffs
Unsuitable for use with	mineral oils & greases, fuels, acids and Heptane

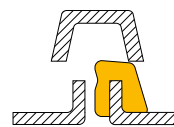

1mm pipework



2mm pipework

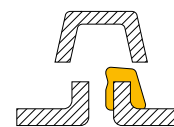

3mm pipework

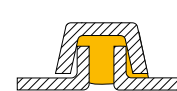

sealed state

DN Nominal Diameter	Part N° 1mm Wall Thickness	Part N° 2mm Wall Thickness	Part N° 3mm Wall Thickness
80	S-80-1	S-80-2	S-80-3
90	S-90-1	S-90-2	S-90-3
100	S-100-1	S-100-2	S-100-3
112	S-112-1	S-112-2	S-112-3
120	S-120-1	S-120-2	S-120-3
125	S-125-1	S-125-2	S-125-3
140	S-140-1	S-140-2	S-140-3
150	S-150-1	S-150-2	S-150-3
160	S-160-1	S-160-2	S-160-3
175	S-175-1	S-175-2	S-175-3
180	S-180-1	S-180-2	S-180-3
200	S-200-1	S-200-2	S-200-3
224	S-224-1	S-224-2	S-224-3
250	S-250-1	S-250-2	S-250-3
280	S-280-1	S-280-2	S-280-3
300	S-300-1	S-300-2	S-300-3
315	S-315-1	S-315-2	S-315-3
350	S-350-1	S-350-2	S-350-3
355	S-355-1	S-355-2	S-355-3
400	S-400-1	S-400-2	S-400-3
450	S-450-1	S-450-2	S-450-3
500	S-500-1	S-500-2	S-500-3
550	S-550-1	S-550-2	S-550-3
560	S-560-1	S-560-2	S-560-3
600	S-600-1	S-600-2	S-600-3
630	S-630-1	S-630-2	S-630-3

Special sizes on request

All measurements are in millimetres.

Rim Seals

made of Keltan/APTK/EPDM, conductive and conform to FDA for use with clamping rings and wall thicknesses of 1, 2 & 3mm

Properties	
Colour	Black
Heat Resistance	-40°C to +150°C
Suitable for use with	Water, steam, acetone, ammonia, alkalis, methyl ethyl ketone, ozone, many acids, foodstuffs
Unsuitable for use with	mineral oils & greases, fuels, heptane, pentane, toluene, chlorinated hydrocarbons



1mm pipework



2mm pipework



3mm pipework



sealed state

DN Nominal Diameter	Part N° 1mm Wall Thickness	Part N° 2mm Wall Thickness	Part N° 3mm Wall Thickness
80	AL-80-1	AL-80-2	AL-80-3
90	AL-90-1	AL-90-2	AL-90-3
100	AL-100-1	AL-100-2	AL-100-3
112	AL-112-1	AL-112-2	AL-112-3
120	AL-120-1	AL-120-2	AL-120-3
125	AL-125-1	AL-125-2	AL-125-3
140	AL-140-1	AL-140-2	AL-140-3
150	AL-150-1	AL-150-2	AL-150-3
160	AL-160-1	AL-160-2	AL-160-3
175	AL-175-1	AL-175-2	AL-175-3
180	AL-180-1	AL-180-2	AL-180-3
200	AL-200-1	AL-200-2	AL-200-3
224	AL-224-1	AL-224-2	AL-224-3
250	AL-250-1	AL-250-2	AL-250-3
280	AL-280-1	AL-280-2	AL-280-3
300	AL-300-1	AL-300-2	AL-300-3
315	AL-315-1	AL-315-2	AL-315-3
350	AL-350-1	AL-350-2	AL-350-3
355	AL-355-1	AL-355-2	AL-355-3
400	AL-400-1	AL-400-2	AL-400-3
450	AL-450-1	AL-450-2	AL-450-3
500	AL-500-1	AL-500-2	AL-500-3
550	AL-550-1	AL-550-2	AL-550-3
560	AL-560-1	AL-560-2	AL-560-3
600	AL-600-1	AL-600-2	AL-600-3
630	AL-630-1	AL-630-2	AL-630-3

All measurements are in millimetres.

Special sizes on request

Two-Part Clamping Ring

for connecting wall thicknesses of 1mm
includes butyl rubber seal



Material

1.0038 galvanized
1.4301 stainless steel
Additional materials and
diameters on request

Profile



DN Nominal Diameter	Inside Diameter A	Bolt DIN912	Material Thickness 1.0038	Material Thickness 1.4301	Weight	Part N°	
						1.0038 galvanized	1.4301 stainless
80	86	M6 x 60	1,5	1,5	0,177	2-1-80	2-1-80-01
90	96	M6 x 60	1,5	1,5	0,184	2-1-90	2-1-90-01
100	106	M6 x 60	1,5	1,5	0,192	2-1-100	2-1-100-01
112	118	M6 x 60	1,5	1,5	0,201	2-1-112	2-1-112-01
120	126	M6 x 60	1,5	1,5	0,207	2-1-120	2-1-120-01
125	131	M6 x 60	1,5	1,5	0,211	2-1-125	2-1-125-01
140	146	M6 x 60	1,5	1,5	0,222	2-1-140	2-1-140-01
150	156	M6 x 60	1,5	1,5	0,230	2-1-150	2-1-150-01
160	166	M6 x 60	1,5	1,5	0,237	2-1-160	2-1-160-01
175	181	M6 x 60	1,5	1,5	0,249	2-1-175	2-1-175-01
180	186	M6 x 60	1,5	1,5	0,253	2-1-180	2-1-180-01
200	206	M6 x 60	1,5	1,5	0,268	2-1-200	2-1-200-01
224	230	M6 x 60	1,5	1,5	0,286	2-1-224	2-1-224-01
250	256	M8 x 60	1,5	1,5	0,380	2-1-250	2-1-250-01
280	286	M8 x 60	1,5	1,5	0,403	2-1-280	2-1-280-01
300	306	M8 x 60	1,5	1,5	0,418	2-1-300	2-1-300-01
315	321	M8 x 60	1,5	1,5	0,429	2-1-315	2-1-315-01
350	356	M8 x 60	1,5	1,5	0,456	2-1-350	2-1-350-01
355	361	M8 x 60	1,5	1,5	0,460	2-1-355	2-1-355-01
400	406	M8 x 60	1,5	1,5	0,494	2-1-400	2-1-400-01
450	456	M8 x 60	1,5	1,5	0,532	2-1-450	2-1-450-01
500	506	M8 x 60	1,5	1,5	0,570	2-1-500	2-1-500-01
550	556	M8 x 60	1,5	1,5	0,608	2-1-550	2-1-550-01
560	566	M8 x 60	1,5	1,5	0,616	2-1-560	2-1-560-01
600	606	M8 x 60	1,5	1,5	0,646	2-1-600	2-1-600-01
630	636	M8 x 60	1,5	1,5	0,669	2-1-630	2-1-630-01

All measurements are in millimetres and weights in kg.

Two-Part Clamping Ring

for connecting wall thicknesses of 2mm
includes butyl rubber seal



Material

1.0038 galvanized
1.4301 stainless steel
Additional materials and
diameters on request

Profile



DN Nominal Diameter	Inside Diameter A	Bolt DIN912	Material Thickness		Weight	Part N°	
			1.0038	1.4301		1.0038 galvanized	1.4301 stainless
80	86	M8 x 60	1,50	1,50	0,262	2-2-80	2-2-80-01
90	96	M8 x 60	1,50	1,50	0,271	2-2-90	2-2-90-01
100	106	M8 x 60	1,75	1,75	0,280	2-2-100	2-2-100-01
112	118	M8 x 60	1,75	1,75	0,290	2-2-112	2-2-112-01
120	126	M8 x 60	1,75	1,75	0,297	2-2-120	2-2-120-01
125	131	M8 x 60	1,75	1,75	0,302	2-2-125	2-2-125-01
140	146	M8 x 60	1,75	1,75	0,315	2-2-140	2-2-140-01
150	156	M8 x 60	1,75	1,75	0,324	2-2-150	2-2-150-01
160	166	M8 x 60	1,75	1,75	0,333	2-2-160	2-2-160-01
175	181	M8 x 60	1,75	1,75	0,346	2-2-175	2-2-175-01
180	186	M8 x 60	1,75	1,75	0,351	2-2-180	2-2-180-01
200	206	M8 x 60	1,75	1,75	0,368	2-2-200	2-2-200-01
224	230	M8 x 60	1,75	1,75	0,390	2-2-224	2-2-224-01
250	256	M8 x 60	1,75	1,75	0,413	2-2-250	2-2-250-01
280	286	M8 x 60	1,75	1,75	0,439	2-2-280	2-2-280-01
300	306	M8 x 60	1,75	1,75	0,457	2-2-300	2-2-300-01
315	321	M8 x 60	1,75	1,75	0,470	2-2-315	2-2-315-01
350	356	M8 x 60	1,75	1,75	0,501	2-2-350	2-2-350-01
355	361	M8 x 60	1,75	1,75	0,506	2-2-355	2-2-355-01
400	406	M8 x 60	1,75	1,75	0,546	2-2-400	2-2-400-01
450	456	M8 x 60	1,75	1,75	0,590	2-2-450	2-2-450-01
500	506	M8 x 60	1,75	1,75	0,634	2-2-500	2-2-500-01
550	556	M8 x 60	1,75	1,75	0,679	2-2-550	2-2-550-01
560	566	M8 x 60	1,75	1,75	0,688	2-2-560	2-2-560-01
600	606	M8 x 60	1,75	1,75	0,723	2-2-600	2-2-600-01
630	636	M8 x 60	1,75	1,75	0,750	2-2-630	2-2-630-01

All measurements are in millimetres and weights in kg.

Two-Part Clamping Ring

for connecting wall thicknesses of 3mm
includes butyl rubber seal



Material

1.0038 galvanized
1.4301 stainless steel
Additional materials and
diameters on request

Profile



DN Nominal Diameter	Inside Diameter A	Bolt DIN912	Material Thickness 1.0038	Material Thickness 1.4301	Weight	Part N°	
						1.0038 galvanized	1.4301 stainless
80	86	M8 x 60	1,50	1,50	0,262	2-3-80	2-3-80-01
90	96	M8 x 60	1,50	1,50	0,271	2-3-90	2-3-90-01
100	106	M8 x 60	1,75	1,75	0,280	2-3-100	2-3-100-01
112	118	M8 x 60	1,75	1,75	0,290	2-3-112	2-3-112-01
120	126	M8 x 60	1,75	1,75	0,297	2-3-120	2-3-120-01
125	131	M8 x 60	1,75	1,75	0,302	2-3-125	2-3-125-01
140	146	M8 x 60	1,75	1,75	0,315	2-3-140	2-3-140-01
150	156	M8 x 60	1,75	1,75	0,324	2-3-150	2-3-150-01
160	166	M8 x 60	1,75	1,75	0,333	2-3-160	2-3-160-01
175	181	M8 x 60	1,75	1,75	0,346	2-3-175	2-3-175-01
180	186	M8 x 60	1,75	1,75	0,351	2-3-180	2-3-180-01
200	206	M8 x 60	1,75	1,75	0,368	2-3-200	2-3-200-01
224	230	M8 x 60	1,75	1,75	0,390	2-3-224	2-3-224-01
250	256	M8 x 60	1,75	1,75	0,413	2-3-250	2-3-250-01
280	286	M8 x 60	1,75	1,75	0,439	2-3-280	2-3-280-01
300	306	M8 x 60	1,75	1,75	0,457	2-3-300	2-3-300-01
315	321	M8 x 60	1,75	1,75	0,470	2-3-315	2-3-315-01
350	356	M8 x 60	1,75	1,75	0,501	2-3-350	2-3-350-01
355	361	M8 x 60	1,75	1,75	0,506	2-3-355	2-3-355-01
400	406	M8 x 60	1,75	1,75	0,546	2-3-400	2-3-400-01
450	456	M8 x 60	1,75	1,75	0,590	2-3-450	2-3-450-01
500	506	M8 x 60	1,75	1,75	0,634	2-3-500	2-3-500-01
550	556	M8 x 60	1,75	1,75	0,679	2-3-550	2-3-550-01
560	566	M8 x 60	1,75	1,75	0,688	2-3-560	2-3-560-01
600	606	M8 x 60	1,75	1,75	0,723	2-3-600	2-3-600-01
630	636	M8 x 60	1,75	1,75	0,750	2-3-630	2-3-630-01

All measurements are in millimetres and weights in kg.

One-Part Clamping Ring

for connecting wall thicknesses of 1 mm
includes butyl rubber seal



Material

1.0038 galvanized
1.4301 stainless steel
Additional materials and
diameters on request

Profile



to DN 224



from DN 250

DN Nominal Diameter	Inside Diameter A	Bolt DIN912	Material Thickness	Weight	Part N° 1.0038 galvanized
80	86	M6 x 60	0,75	0,078	1-80
90	96	M6 x 60	0,75	0,081	1-90
100	106	M6 x 60	0,75	0,084	1-100
112	118	M6 x 60	0,75	0,087	1-112
120	126	M6 x 60	0,75	0,090	1-120
125	131	M6 x 60	0,75	0,091	1-125
140	146	M6 x 60	0,75	0,095	1-140
150	156	M6 x 60	0,75	0,098	1-150
160	166	M6 x 60	0,75	0,101	1-160
175	181	M6 x 60	0,75	0,105	1-175
180	186	M6 x 60	0,75	0,106	1-180
200	206	M6 x 60	0,75	0,112	1-200
224	230	M6 x 60	0,75	0,119	1-224
250	256	M8 x 60	1,50	0,285	1-250
280	286	M8 x 60	1,50	0,308	1-280
300	306	M8 x 60	1,50	0,323	1-300
315	321	M8 x 60	1,50	0,334	1-315
350	356	M8 x 60	1,50	0,360	1-350
355	361	M8 x 60	1,50	0,364	1-355
400	406	M8 x 60	1,50	0,398	1-400
450	456	M8 x 60	1,50	0,435	1-450
500	506	M8 x 60	1,50	0,473	1-500
550	556	M8 x 60	1,50	0,510	1-550
560	566	M8 x 60	1,50	0,518	1-560
600	606	M8 x 60	1,50	0,548	1-600
630	636	M8 x 60	1,50	0,570	1-630

All measurements are in millimetres and weights in kg.

Wide Strap Clamping Ring

for connecting longitudinal and spiral seamed ducting with beaded rim



Material

1.0038 galvanized
1.4301 stainless steel
Additional materials and diameters on request

Profile



DN Nominal Diameter	Inside Diameter A	Bolt DIN912	Material Thickness	Weight	Part N° 1.0038 galvanized
80	86	M8 x 70	1	0,290	1W-80-V
90	96	M8 x 70	1	0,302	1W-90-V
100	106	M8 x 70	1	0,315	1W-100-V
112	118	M8 x 70	1	0,330	1W-112-V
120	126	M8 x 70	1	0,340	1W-120-V
125	131	M8 x 70	1	0,346	1W-125-V
140	146	M8 x 70	1	0,365	1W-140-V
150	156	M8 x 70	1	0,377	1W-150-V
160	166	M8 x 70	1	0,390	1W-160-V
175	181	M8 x 70	1	0,408	1W-175-V
180	186	M8 x 70	1	0,414	1W-180-V
200	206	M8 x 70	1	0,439	1W-200-V
224	230	M8 x 70	1	0,469	1W-224-V
250	256	M8 x 70	1	0,502	1W-250-V
280	286	M8 x 70	1	0,539	1W-280-V
300	306	M8 x 70	1	0,564	1W-300-V
315	321	M8 x 70	1	0,583	1W-315-V
350	356	M8 x 70	1	0,627	1W-350-V
355	361	M8 x 70	1	0,633	1W-355-V
400	406	M8 x 70	1	0,689	1W-400-V
450	456	M8 x 70	1	0,752	1W-450-V
500	506	M8 x 70	1	0,814	1W-500-V
550	556	M8 x 70	1	0,641	1W-550-V
560	566	M8 x 70	1	0,889	1W-560-V
600	606	M8 x 70	1	0,939	1W-600-V
630	636	M8 x 70	1	0,976	1W-630-V

All measurements are in millimetres and weights in kg.







BENDING TECHNIQUES

With decades of experience as a supplier for both trade and industry we have grown together with our customers and as such have a deep understanding of their needs. Quality, delivered quickly and on time. In order to exceed these expectations we employ a comprehensive machine park for cold bending of a variety of steels, aluminium and stainless steel profiles to rings, hoops, arcs and curved segments.

Our manufacturing plants in Germany, Poland and the United Arab Emirates enable us to be fast, flexible and cost-effective in the service of our customers. Individual customer requirements from a multitude of areas of use in many countries are the rule not the exception. For this reason we accompany the customer, with our professional expertise, from the planning phase right up to the finished product. Dependent on the product, we provide individual solutions tailored to the customer's needs. Skill, precision and punctuality are our guiding principles.

Comprehensive projects with exceptional requirements in respect of size and weight are no particular challenge. We have extensive experience in structural, civil, plant, tank and vessel engineering.

We bend steel, aluminium and stainless steel sections for the following industries:

- Recycling
- Architecture
- Metalworking
- Automotive
- Chemical
- Foodstuffs
- Construction & Designer Construction
- Pharmaceutical
- Agriculture













Our bent and formed parts can be found in the following areas:

- Steelwork
- Structural engineering
- Mechanical Engineering
- Offshore engineering
- Conveyor Technology
- Advertising Technology
- Silo Construction
- Environmental Engineering
- Storage Tank & Vessel Construction

One Stop Sourcing – Our Manufacturing Skills:

- Engineering & Prototyping
- Mechanical processing
- Structural shape
- Certified welding
- Surface refinement
- Sizing & Cutting

BENDING SELECTIONS

	Section	Minimum dimensions (in mm)	Maximum dimensions (in mm)
	Flat steel (strong axis / x-x)	15x3	200x60
	Flat steel (weak axis / y-y)	15x3	400x80
	Solid square	5x5	140x140
	Solid round	ø3	ø 150
	Angle (toe out)	20x10x3	200x200x25
	Angle (toe in)	20x10x3	200x200x20
	T-Section (toe out)	15x3	200x25
	T-Section (toe in)	15x3	200x20
	T-Section (toe up)	15x3	200x25
	Rectangular tube (strong axis / x-x)	20x10x1,5	200x100x10
	Rectangular tub (weak axis / y-y)	20x10x1,5	200x100x12
	Square tube	15x15x2	180x180x12

	Section	Minimum dimensions <i>(in mm)</i>	Maximum dimensions <i>(in mm)</i>
	U-Section <i>(toe out / y-y)</i>	UPN 30	UPN 475
	U-Section <i>(toe in / y-y)</i>	UPN 30	UPN 475
	U-Section <i>(toe up / x-x)</i>	UPN 30	UPN 260
	I-Section <i>(weak axis / y-y)</i>	IPE 80	IPE 450
	I-Section <i>(strong axis / x-x)</i>	IPE 80	IPE 270
	H-Section <i>(weak axis / y-y)</i>	HEA 100	HEA 280
	H-Section <i>(strong axis / x-x)</i>	HEA 100	HEA 240
	H-Section <i>(strong axis / x-x)</i>	HEB 100	HEB 220
	Circular hollow section (CHS)	ø10x2	ø324x4,5
	Heavy duty CHS	ø20x3	ø273x9,3
	Railway track	on request	on request





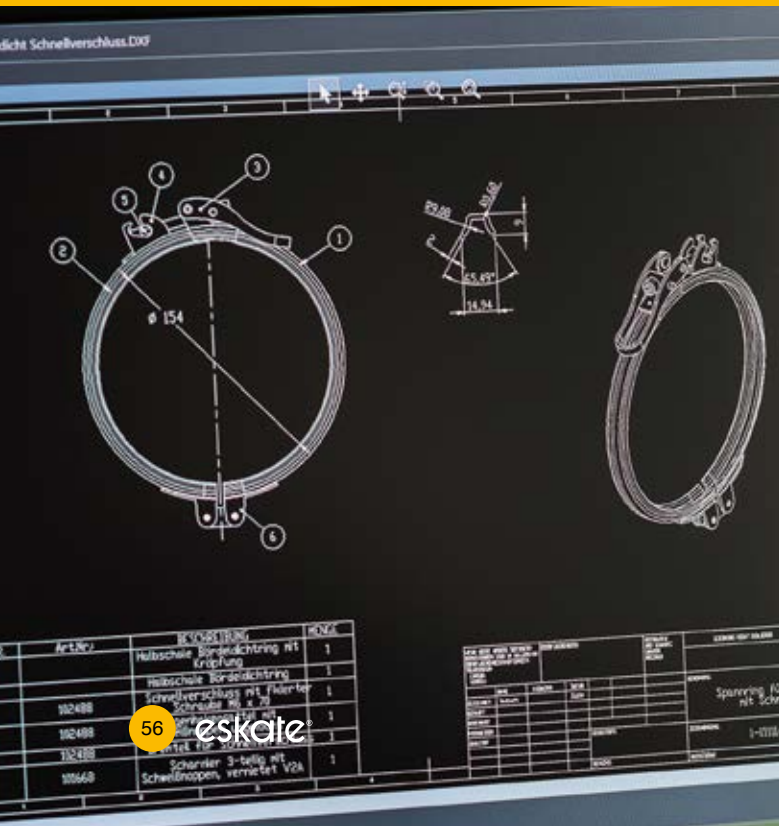

DESIGN AND DEVELOPMENT

We manufacture a great many different clamping rings, which we create together with our customers from various industries with very different product requirements. Regardless of whether mass or batch production, we develop the solution guaranteed to best suit you in order to design your product individually, economically and efficiently.

Particular preferences for extraordinary dimensions are not uncommon to us and are developed and fulfilled by our designers in close contact with you. We are also happy to put your ideas or factory standards into practice in line with drawings provided.

Our unique clamping rings are in use in radar stations, drum and barrel closures, telegraph and broadcasting stations, loading terminals, and everywhere where media have to be conveyed via a duct system.

UNIQUE CLAMPING RINGS

- > Radar stations
- > Sight glasses
- > Drum and barrel manufacture
- > Pail and bucket lids
- > Telegraph and broadcasting stations
- > Tunnel exhaust and ventilation
- > Loading terminals
- > Filtration plants
- > Pipeline construction
- > Stainless steel and chimney technology



NR.	Art.Nr.	BESCHREIBUNG	MENGE
		Halbschale Bördeldichtring mit Kröpfung	1
		Halbschale Bördeldichtring	1
		Dichtring mit fixierter	1

NEUER KOSTEN-ÜBERSICHTS-RECHENBILDERN		BESTELLMENGEN		ENTWICKELUNG		RECHENBILDERN	
NR.	ART.NR.	BEZUGSNUMMER	STÜCKZAHLEN	STÜCKZAHLEN	STÜCKZAHLEN	STÜCKZAHLEN	STÜCKZAHLEN

eskate® 57



Materials

Non-alloy construction steel

- > 1.0038 (St-37-2 / S235JRG2)
- > 1.0570 (St52-3 / S355JR)

Pressure vessel construction steel

- > 1.0425 (H11/P265GH)
- > 1.5415 (16Mo3)

Stainless steel

- > 1.4301 (X5CrNi-18-10)
- > 1.4307 (X2CrNi18-9)
- > 1.4541 (X6CrNiTi18-10)
- > 1.4571 (X6CrNiMoTi17-12-2)
- > 1.4404 (X2CrNiMo17-12-2)
- > 1.4828 (X15CrNiSi20-12)
- > 1.4841 (X15CrBiSi 25-21))
- > 1.4539 (X1NiCrMoCu25-20-5)
- > 1.4462 (X2CrNiMoN22-5-3/-)

Aluminium

- > 3.3206 (AlMgSi0,5/EN AW-6060)
- > 3.3535 (AlMg3/EN AW-5754)
- > 3.3547 (AlMg4,5/EN AW-5083)

VERSIONS AND FINISHES

- > polished
- > stained
- > chrome-plated
- > smoothed
- > sand-blasted
- > bead-blasted
- > metal-shot-blasted
- > galvanized in accordance with DIN EN ISO 1461
- > galvanized in accordance with DIN EN 12329 and DIN 50979
- > powder-coated in RAL colour tones

Additional materials and refining on request.

FURTHER MANUFACTURING PROCESSES



Firing and laser technology, water-jet cutting

With cutting-edge stamping, firing and laser technology systems, as well as water-jet cutting, we offer you the chance of producing segment parts, round plates and pressure rated flanges (e.g., with reduced sheet thickness, the utmost precision and at an affordable price).



CNC manufacturing technologies

We are able to guarantee the utmost quality In these business fields too. We use cutting-edge machinery to manufacture a broad range of individual parts, series parts and modules for the mechanical and plant engineering industry.



Surface processing

Many of the products we develop and manufacture are given a special finish, not merely for aesthetic reasons, but often because they need to be extremely weather-resistant and are exposed to other mechanical stresses. Protection against corrosion and wear and tear is therefore essential.



Welding

We weld every common form of steel, stainless steel or aluminium using MIG-, MAG- and WIG-welding processes. In particular welded assemblies make up a great part of our core skills. On request, we carry out an ultrasonic inspection of the weld.



4000 storage bins

OUR SPEED IS YOUR TRUMP CARD

Framework agreements ensure certainty in planning with immediate availability.

Thanks to our manufacturing processes and the continuous availability of raw materials, we are able to manufacture flanges, rings, hoops, clamping rings and collars within a very short timeframe. As we do so, the entire value creation chain remains seamlessly in our hands. This creates speed while at the same time reducing costs. We complete series and call orders in line with the customer's requirements and store these specifically for our customers.

This way we guarantee your preferred delivery date when your order is placed.

The goods leave the factory on the same day as the call-off order is placed. At the same time, we protect you as a system supplier from any delays in supply for your international projects, in your automated further processing, or in the onward sale of our products. For this purpose we offer our customers comprehensive global delivery using our own methods of transport, via sea or air with the help of longstanding, trusted logistics partners.







QUALITY – FAST, FLEXIBLE AND GLOBAL

Storage and logistics

- › All common DIN/EN standards are immediately available from stock
- › Individual call orders and storage of factory standards
- › Over 4000 pallet bays – on six levels
- › ERP-supported warehouse administration in real time
- › Very short lead times
- › Immediate access to the primary material
- › Efficient logistics with renowned logistics partners and the company's own fleet
- › International shipping and customs clearance

Quality management

- › **Certified DIN EN ISO 9001:2015 and DIN EN ISO 14001:2015**
- › High quality standards, thanks to continuous checks in the individual manufacturing levels
- › Carefully selected, high-quality primary materials
- › Quality end controls before storage and/or before dispatch to the customer
- › Ultrasound check
- › Surface crack testing



eskate®



ESKATE Rohrverbindungstechnik GmbH
Köhlterholz 7 | Industriegebiet
D-32479 Hille-Unterlübbe

Fon +49 5734 6666-6
Fax +49 5734 6666-00
eMail info@eskate.de

POLAND

ESKATE® Polska Sp. z o. o.
ul. Przemysłowa 2
88-140 Gniewkowo
eMail biuro@eskate.pl
Fon +48 52 35 58 38 0

UNITED ARAB EMIRATES

ESKATE® Middle East FZ-LLC
PO BOX: 6455 street F7, Block A Plot No. 28
Al-Jazeera - Al Hamra, Ras al Khaimah
eMail info@eskate.com
Fon +971 7 24 38 33 9

TURKEY

ESKATE® Türkiye
Taşköprü Sanayi Sitesi
1 yol no:114, Taşköprü / Çiftlikköy-Yalova
İstanbul
eMail info@eskate.com.tr
Fon +90 226 81 31 50 6